

For Your Convenience

Please contact Sony directly if you:

- Have questions on the use of your television after reading your manual
- Experience difficulty operating your television

Contact Sony Customer Support at:

<http://www.sony.com/tvsupport>

or to speak with a support representative:

United States

1-800-222-SONY (7669)

8:00 AM - 10:00 PM (EST) Mon - Fri

10:30 AM - 7:15 PM (EST) Sat - Sun

Canada

1-877-899-SONY (7669)

8:00 AM - 6:00 PM (Eastern)

8:00 AM - 5:00 PM (Western)

Sony will work to resolve your questions more quickly than your retailer or place of purchase.

Please Do Not Return the Product to the Store

SXRD
Silicon X-tal Reflective Display



2686615131

<http://www.sony.net/>

Printed in U.S.A.

SXRD Projection TV Operating Instructions

KDS-50A2000

KDS-55A2000

KDS-60A2000

© 2006 Sony Corporation

HDMI™
HIGH-DEFINITION MULTIMEDIA INTERFACE

WEGA ENGINE™ **HDTV™**
HIGH-DEFINITION TELEVISION

Owner's Record

The model and serial numbers are located at the rear of the TV. Record these numbers in the spaces provided below. Refer to them whenever you call upon your Sony dealer regarding this product.

Model No. _____

Serial No. _____

For Your Convenience

Please contact Sony directly if you:

- Have questions on the use of your television after reading your manual
- Experience difficulty operating your television

Contact Sony Customer Support at:

<http://www.sony.com/tvsupport>

or to speak with a support representative:

United States

1-800-222-SONY (7669)

8:00 AM - 10:00 PM (EST) Mon - Fri

10:30 AM - 7:15 PM (EST) Sat - Sun

Canada

1-877-899-SONY (7669)

8:00 AM - 6:00 PM (Eastern)

8:00 AM - 5:00 PM (Western)

Sony will work to resolve your questions more quickly than your retailer or place of purchase.

Please Do Not Return the Product to the Store

WARNING

To reduce the risk of fire or electric shock, do not expose this apparatus to rain or moisture.



This symbol is intended to alert the user to the presence of uninsulated “dangerous voltage” within the product’s enclosure that may be of sufficient magnitude to constitute a risk of electric shock to persons.



This symbol is intended to alert the user to the presence of important operating and maintenance (servicing) instructions in the literature accompanying the appliance.

The apparatus shall not be exposed to dripping or splashing and no objects filled with liquids, such as vases, shall be placed on the apparatus.

CAUTION

To prevent electric shock, do not use this polarized AC plug with an extension cord, receptacle or other outlet unless the blades can be fully inserted to prevent blade exposure.

Note on Caption Vision

This TV provides display of TV closed captioning in accordance with §15.119 of the FCC rules.

Declaration of Conformity

Trade Name: SONY
 Model: KDS-50A2000/KDS-55A2000/KDS-60A2000
 Responsible Party: Sony Electronics Inc.
 Address: 16530 Via Esprillo,
 San Diego, CA 92127 U.S.A.
 Telephone Number: 858-942-2230

This device complies with part 15 of the FCC rules. Operation is subject to the following two conditions: (1) This device may not cause harmful interference, and (2) this device must accept any interference received, including interference that may cause undesired operation.

NOTIFICATION

This equipment has been tested and found to comply with the limits for a Class B digital device, pursuant to Part 15 of the FCC Rules. These limits are designed to provide reasonable protection against harmful interference in a residential installation. This equipment generates, uses and can radiate radio frequency energy and, if not installed and used in accordance with the instructions, may cause harmful interference to radio communications. However, there is no guarantee that interference will not occur in a particular installation. If this equipment does cause harmful interference to radio or television reception, which can be determined by turning the equipment off and on, the user is encouraged to try to correct the interference by one or more of the following measures:

- Reorient or relocate the receiving antenna.
- Increase the separation between the equipment and receiver.
- Connect the equipment into an outlet on a circuit different from that to which the receiver is connected.
- Consult the dealer or an experienced radio/TV technician for help.

Pursuant to FCC regulations, you are cautioned that any changes or modifications not expressly approved in this manual could void your authority to operate this equipment.

For Customers in Canada

This Class B digital apparatus complies with Canadian ICES-003.

Safety

- Operate the TV only on 120 V AC.
- The plug is designed, for safety purposes, to fit into the wall outlet only one way. If you are unable to insert the plug fully into the outlet, contact your dealer.
- If any liquid or solid object should fall inside the cabinet, unplug the TV immediately and have it checked by qualified service personnel before operating it further.
- If you will not be using the TV for several days, disconnect the power by pulling the plug itself. Never pull on the cord.
- For details concerning safety precautions, see “Important Safety Instructions” on page 5.

Installing

- The TV should be installed near an easily accessible power outlet.
- To prevent internal heat buildup, do not block the ventilation openings.
- Do not install the TV in a hot or humid place, or in a place subject to excessive dust or mechanical vibration.
- Use the TV at temperatures between 41°F (5°C) and 95°F (35°C).
- If the TV is transported directly from a cold to a warm location, or if the room temperature changes suddenly, the picture may be blurred or show poor color due to moisture condensation. In this case, please wait a few hours to let the moisture evaporate before turning on the TV.
- To obtain the best picture, do not expose the screen to direct illumination or direct sunlight. It is recommended to use spot lighting directed down from the ceiling or to cover the windows that face the screen with opaque drapery. It is desirable to install the TV in a room where the floor and walls are not of a reflective material.
- See pages 11 and 12 for more information on the installation.

CAUTION

Use the following Sony appliance(s) only with the following TV STAND. Use with other TV STAND may cause instability and possibly result in injury.

	SONY APPLIANCE MODEL NO.		
	KDS-50A2000	KDS-55A2000	KDS-60A2000
SONY TV STAND MODEL NO.	SU-RS11M	SU-RS11X	

To Customers

Sufficient expertise is required for installing the specified product. Be sure to subcontract the installation to Sony dealers or licensed contractors and pay adequate attention to safety during the installation.

(Continued)

Note

This digital television is capable of receiving analog basic and digital basic television programming by direct connection to a cable system providing such programming. Certain premium, advanced and interactive digital cable services such as video-on-demand, a cable operator's enhanced program guide and data-enhanced television services may require the use of a set-top box. For more information call your local cable operator.

This television includes a QAM demodulator which should allow you to receive unscrambled digital cable television programming via subscription service to a cable service provider. Availability of digital cable television programming in your area depends on the type of programming and signal provided by your cable service provider.

Trademark Information



© TruSurround XT, SRS and (●) symbol are trademarks of SRS Labs, Inc. TruSurround XT technology is incorporated under license from SRS Labs, Inc.



Manufactured under license from BBE Sound, Inc.

© Licensed by BBE Sound, Inc. under one or more of the following US patents: 5510752, 5736897. BBE and BBE symbol are registered trademarks of BBE Sound, Inc.

Macintosh is a trademark licensed to Apple Computer, Inc., registered in the U.S.A and other countries.

Blu-ray Disc is a trademark.

SXRD, WEGA, Grand WEGA, Steady Sound, Digital Reality Creation and CineMotion are registered trademarks of Sony Corporation.



This TV is manufactured under license from Dolby Laboratories. "Dolby" and the double-D symbol are trademarks of Dolby Laboratories.



This TV incorporates High-Definition Multimedia Interface (HDMI™) technology. HDMI, the HDMI logo and High-Definition Multimedia Interface are trademarks or registered trademarks of HDMI Licensing LLC.



Important Safety Instructions

- 1) Read these instructions.
- 2) Keep these instructions.
- 3) Heed all warnings.
- 4) Follow all instructions.
- 5) Do not use this apparatus near water.



- 6) Clean only with dry cloth.



- 7) Do not block any ventilation openings. Install in accordance with the manufacturer's instructions.

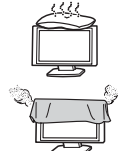

- 8) Do not install near any heat sources such as radiators, heat registers, stoves, or other apparatus (including amplifiers) that produce heat.



- 9) Do not defeat the safety purpose of the polarized or grounding-type plug. A polarized plug has two blades with one wider than the other. A grounding type plug has two blades and a third grounding prong. The wide blade or the third prong are provided for your safety. If the provided plug does not fit into your outlet, consult an electrician for replacement of the obsolete outlet.



- 10) Protect the power cord from being walked on or pinched particularly at plugs, convenience receptacles, and the point where they exit from the apparatus.



- 11) Only use attachments/accessories specified by the manufacturer.



- 12) Use only with the cart, stand, tripod, bracket, or table specified by the manufacturer, or sold with the apparatus. When a cart is used, use caution when moving the cart/apparatus combination to avoid injury from tip-over.



- 13) Unplug this apparatus during lightning storms or when unused for long periods of time.



- 14) Refer all servicing to qualified service personnel. Servicing is required when the apparatus has been damaged in any way, such as power-supply cord or plug is damaged, liquid has been spilled or objects have fallen into the apparatus, the apparatus has been exposed to rain or moisture, does not operate normally, or has been dropped.



- Be sure to observe the TV's "For Safety" section on page 6.

Antennas

Outdoor Antenna Grounding

If an outdoor antenna is installed, follow the precautions below. An outdoor antenna system should not be located in the vicinity of overhead power lines or other electric light or power circuits, or where it can come in contact with such power lines or circuits.

WHEN INSTALLING AN OUTDOOR ANTENNA SYSTEM, EXTREME CARE SHOULD BE TAKEN TO KEEP FROM CONTACTING SUCH POWER LINES OR CIRCUITS AS CONTACT WITH THEM IS ALMOST INVARIABLY FATAL.

Be sure the antenna system is grounded so as to provide some protection against voltage surges and built-up static charges.

Section 810 of the National Electrical Code (NEC) in USA and Section 54 of the Canadian Electrical Code in Canada provides information with respect to proper grounding of the mast and supporting structure, grounding of the lead-in wire to an antenna discharge unit, size of grounding conductors, location of antenna discharge unit, connection to grounding electrodes, and requirements for the grounding electrode.

(Continued)

Antenna Grounding According to the NEC

Refer to section 54-300 of Canadian Electrical Code for Antenna Grounding.

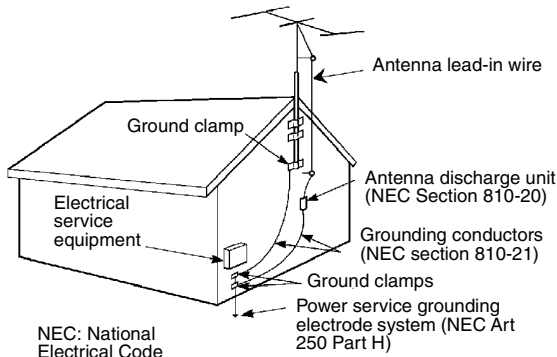

Cleaning

- Clean the rear cover area of the TV regularly. Dust in the rear cover area may cause a problem with the cooling system of the TV set.
- Clean the cabinet of the TV with a dry soft cloth. To remove dust from the screen, wipe it gently with a soft cloth. Stubborn stains may be removed with a cloth slightly dampened with solution of mild soap and warm water. Never use strong solvents such as thinner or benzine for cleaning. If the picture becomes dark after using the TV for a long period of time, it may be necessary to clean the inside of the TV. Consult qualified service personnel.
- Unplug the AC power cord when cleaning this unit. Cleaning this unit with a plugged AC power cord may result in electric shock.



On Contamination on the Screen Surface

The screen surface has a special coating to reduce reflections. To prevent screen damage, clean the screen as follows:

- Clean the screen with a soft cloth.
- To remove hard contamination, use a cloth moistened with a solution of mild soap and warm water. Do not spray cleaning solution directly onto the TV. It should only be sprayed to moisten the cleaning cloth.
- Do not use any type of abrasive pad, alkaline cleaner, acid cleaner, scouring powder, chemical cloth, or solvent such as alcohol, benzene or thinner, as these may scratch the screen's coating.

Service

Damage Requiring Service

Do not attempt to service the set by yourself since opening the cabinet may expose you to dangerous voltage or other hazards.

Unplug the set from the wall outlet and refer servicing to qualified service personnel.



Replacement Parts

When replacement parts are required, be sure the service technician certifies in writing that he has used replacement parts specified by the manufacturer that have the same characteristics as the original parts.

Unauthorized substitutions may result in fire, electric shock or other hazards.

See "Replacing the Lamp" on page 51.

For Safety

Be Careful When Moving the TV

When you place the TV in position, be careful not to drop it on your foot or fingers.

Watch your footing while installing the TV.



Carry the TV in the Specified Manner

If you carry the TV in a manner other than the specified manner and without the specified number of persons, it may drop and a serious injury may be caused. Be sure to follow the instructions mentioned below.

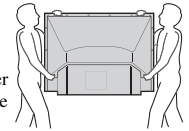

- Carry the TV with the specified number of persons (see page 11).
- Hold the TV tightly when carrying it.
- Before carrying the TV, disconnect any accessories or cables.

About the TV

Although the TV is made with high-precision technology, black dots may appear or bright points of light (red, blue, or green) may appear constantly on the screen. This is a structural property of the panel and is not a defect.

Installation

- If direct sunlight or other strong illumination shines on the screen, part of the screen may appear white due to reflections from behind the screen. This is a structural property of the TV. Do not expose the screen to direct illumination or direct sunlight.
- The picture quality may be affected by your viewing position. For the best picture quality, install your TV according to "Recommended Viewing Area" on page 13.
- When installing your TV against a wall, keep it at least 4 inches (10 cm) away from the wall.

Projection Lamp

- Your TV uses a projection lamp as its light source. It is time to replace the lamp with a new one (not supplied) when:
 - the message, "Projection lamp is nearing end of life. Please replace the lamp." appeared on the screen,
 - the lamp replacement indicator on the front panel blinks in red,
 - screen images become dark,
 - no image appears on the display after prolonged use.
- In rare instances, the bulb may pop inside the lamp unit, but the lamp unit is designed to contain all of broken glass pieces inside the lamp unit. (See "Replacing the Lamp" on page 51.)
- When the lamp eventually burns out, you may hear a noticeable pop sound. This is normal and is inherent in this type of lamp.

Cooling Fan

This TV uses a cooling fan. You may hear the noise of fan running, depending on the placement of your TV. The noise may be more noticeable during the night or when the background noise level is low.

Objects and Ventilation Holes

Never push objects of any kind into the unit through the cabinet slots as they may touch dangerous voltage points or short out parts that could result in a fire or electric shock. Never spill liquid of any kind on the unit.



Disposal of Used Batteries

To preserve our environment, dispose of used batteries according to your local laws or regulations.

Contents

Getting Started

Welcome	8
Features	8
Notes on the TV	9
Screen	10
Projection Lamp	10
Installing the TV	11
Carrying Your TV	11
Take Precaution during Installation	11
Preventing the TV from Toppling Over	11
When Installing Your TV against a Wall	12
Recommended Viewing Area	13
Connecting the TV	14
Cable System and VHF/UHF Antenna System	14
Cable Box/Digital Cable Box and Antenna	14
Cable Box/Digital Cable Box	15
Satellite Receiver and Cable/Antenna	15
VCR and Cable	16
VCR and Cable Box/Digital Cable Box	17
When Connecting to Optional Equipment	18
Front Panel	18
Rear Panel	19
Setting Up the Channel List - Initial Setup	21

Basic Operations

Using the Remote Control	22
Programming the Remote Control	26
Using Other Equipment with Your Remote Control	28
TV Controls	31

Using the Menus

Overview of MENU	32
Picture Settings	34
Sound Settings	37
Screen Settings	39
Channel Settings	41
Parental Lock Settings	42
Setup Settings	45
PC Settings	49

Other Information

Replacing the Lamp	51
How to Replace the Lamp	51
Troubleshooting	55
Remote Control	55
Picture	56
Sound	57
Channels	57
General	58
PC Input Signal Reference Chart	60
Specifications	61
Index	62

Getting Started

Welcome

Thank you for purchasing this Sony SXRD™ projection TV. This manual is for models KDS-50A2000, KDS-55A2000 and KDS-60A2000.

Features

Some of the features that you will enjoy with your new TV include:

- ❑ **SXRD™:** SXRD is a Silicon X-tal Reflective Display technology that delivers high-level resolution, greater contrast ratio, faster response speed and film-like reproduction compared to other conventional devices.
- ❑ **WEGA Engine:** Delivers superb picture quality from any video source by minimizing the signal deterioration caused by digital-to-analog conversion and stabilizing the signal processing. This engine features unique Sony technology, including:
 - **DRC® (Digital Reality Creation)-MF V1:** Unlike conventional line doublers, the DRC Multifunction feature replaces the signal's NTSC waveform with the near-HD equivalent by digital mapping processing. The DRC Palette option lets you customize the level of detail (Reality) and smoothness (Clarity).
- ❑ **Integrated HDTV:** You can watch digital televised programs and enjoy the improved audio/video quality offered by these programs.
- ❑ **Advanced Iris:** Automatically detects the brightness of the screen. By adjusting the iris shutter, this feature can provide you with the best contrast and brightness from one scene to the next for your TV viewing.
- ❑ **Wide Screen Mode:** Allows you to watch 4:3 normal broadcasts in wide screen mode (16:9 aspect ratio).
- ❑ **CineMotion®:** Using the reverse 3-2 pull down technology, the CineMotion feature provides smoother picture movement when playing back movies or other video sources on film.
- ❑ **MENU:** Sony's unique user interface provides easy access to the popular and useful TV functions such as external inputs (switch among connected equipment), favorite channels (create a list of your favorite channels), cable channels (view cable channels), antenna channels (view antenna channels) or to customize your TV settings.
- ❑ **Parental Control:** Downloadable digital rating and V-Chip technology allows parents to block unsuitable programming from younger viewers.
- ❑ **Component Video Inputs:** Offers a high-quality video for DVD (480p, 480i) and digital set-top box (1080i, 720p, 480p, 480i) connections.
- ❑ **S VIDEO Inputs:** Provides high-quality image from connected equipment.

- ❑ **Favorite Channels:** Using the MENU function, you can view and select from a list of up to 16 favorite channels without leaving the current channel.
- ❑ **Steady Sound[®]:** Equalizes volume levels so there is consistent output between programs and commercials.
- ❑ **PC Input:** Allows you to connect your PC and display the PC screen on your TV.
- ❑ **HDMI (High-Definition Multimedia Interface):** Provides an uncompressed, all-digital audio/video interface between this TV and any HDMI-equipped audio/video component, such as a set-top box, Blu-ray Disc™ Player (BD), DVD player, and A/V receiver. HDMI supports enhanced, or high-definition video, plus two-channel digital audio.

Notes on the TV

To enjoy clear picture

- ❑ Prevent sunlight or other light sources from shining directly onto the screen.
- ❑ The screen surface is easily scratched. Do not rub, touch, or tap it with sharp or abrasive objects (see “On Contamination on the Screen Surface” on page 6).

When not using the TV for a long period of time

- ❑ Unplug the AC power cord from the outlet if you anticipate not using the TV for more than a week.

When turning off the power

- ❑ The cooling fan will continue to operate for about two minutes. Allow several minutes before unplugging from the outlet or switching the breaker off.

On moisture condensation

- ❑ If your TV is moved directly from a cold to a warm location or is placed in a humid room, or if the room temperature changes suddenly, the picture may blur or show poor color. This is caused by moisture condensation on the lenses inside. Wait a few hours to let the moisture evaporate before turning on the TV. When the condensation has evaporated, the picture will return to normal.

Screen

To minimize reflection, the screen surface has a special coating. Inappropriate cleaning methods could damage the screen surface. Special care is required.

Cleaning the Screen Surface

Dust and dirt on the screen can affect the picture quality. To dust off the screen use a soft cloth. Be sure to follow the cleaning instruction on page 6 for stubborn stains and dirt.

Temporary Image Retention



When high contrast non-moving images such as station logos and channel numbers are displayed for a long period of time, there may be some image retention on the screen. This is only a temporary condition. Turning off the power for a while or letting the TV run on another channel will eliminate the retained image.

Projection Lamp

To replace the lamp, see page 51.

Your TV uses a projection lamp as its light source. As with any lamp, it has a lifespan and needs to be replaced when the LAMP LED blinks or the screen becomes darker. Your TV also has a function to display a message “Projection lamp is nearing end of life. Please replace the lamp.” to let you know that the lamp has reached its expected lifespan. Note the following:

- ❑ After turning on your TV, it may take a while (1 minute or less) before the picture appears.
- ❑ When the projection lamp wears out, the screen goes dark. Replace the lamp with a new Sony XL-5200 replacement lamp (not supplied).
- ❑ After the lamp is replaced, set the **Lamp Replacement** option in the **Setup** settings (see page 47).

-  Until you set the **Lamp Replacement** option, a message announcing that the lamp is at the end of its life will appear every time you turn on your TV.
-  The light emitted from the lamp is quite bright when your TV is in use. To avoid eye discomfort or injury, do not look into the light housing when the power is on.

Installing the TV

Carrying Your TV

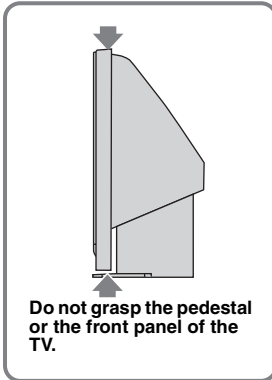

Carrying the TV requires at least two people. Do not hold by the pedestal or the front panel of the TV. Doing so may cause these parts to break off. When moving the TV, place one hand in the hole on the lower portion of the TV while supporting the top with the other hand, as shown in the illustration below.

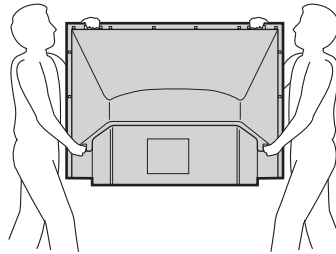

If you have connected cables and cords, be sure to unplug them before moving the TV.

Take Precaution during Installation

To ensure the safety of children and the TV, keep children away from the TV during installation. Climbing on or pushing the TV or its stand may cause it to fall and damage the TV.

Preventing the TV from Toppling Over

As a protective measure, secure the TV as follows.

Using the TV stand with support belts

- ❑ Sony strongly recommends using the TV stand SU-RS11M (for KDS-50A2000)/SU-RS11X (for KDS-55A2000, KDS-60A2000) with a support belt designed for your TV.

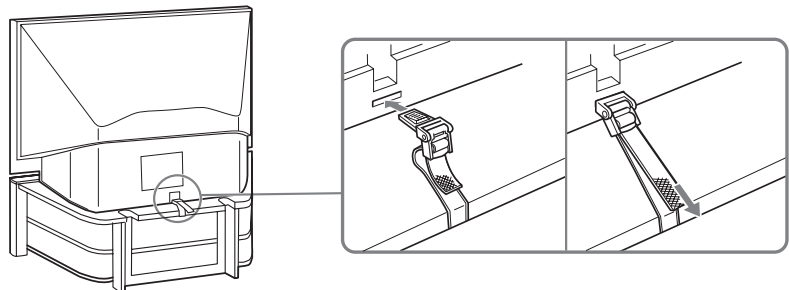

- 🔧 When using the SU-RS11M (for KDS-50A2000)/SU-RS11X (for KDS-55A2000, KDS-60A2000) stand for your TV, you must use the support belt.

When Installing Your TV against a Wall

Keep your TV at least 4 inches (10 cm) away from the wall to provide proper ventilation. Blocking the ventilation opening of the cooling fan may damage the TV.

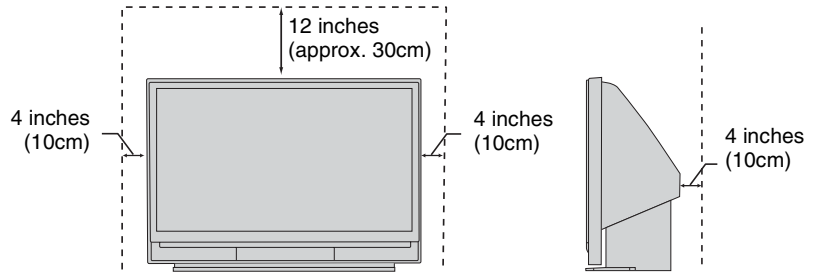

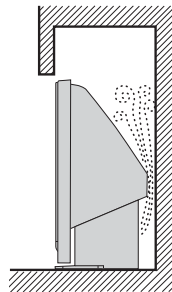

Never install the TV as follows

Air circulation is blocked

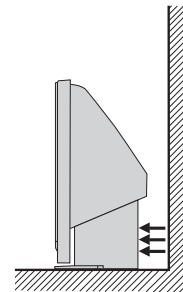

Air blown into the cooling fan



 Do not install the TV near any ventilation, as it may affect the normal TV operating temperature.



Recommended Viewing Area

Your viewing position may affect the picture quality.

For the best picture quality, install your TV within the areas shown below.

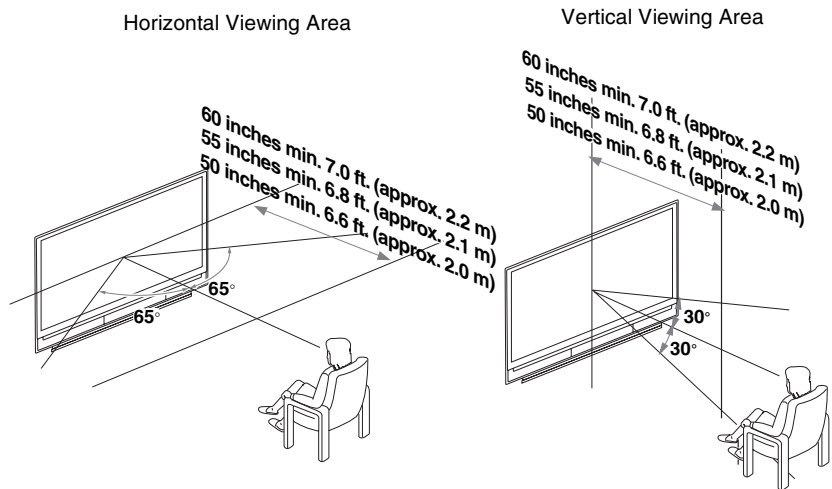
<i>Model</i>	<i>Viewing distance</i>
KDS-50A2000	min. 6.6 ft. (approx. 2.0 m)
KDS-55A2000	min. 6.8 ft. (approx. 2.1 m)
KDS-60A2000	min. 7.0 ft. (approx. 2.2 m)



-  Install the TV in a location that avoids reflections from external light sources.
-  Reflections from external light sources may cause unwanted illuminations in certain areas of the picture (typically dark areas). These types of illuminations can occur with the TV's power on or off.

Connecting the TV

To display clear crisp pictures, you must connect your TV correctly and select the correct **Wide Mode** to display the picture in the correct aspect ratio (see “Changing the Wide Screen Mode” on page 25). It is strongly recommended that you connect the antenna/cable input using 75-ohm coaxial cable to receive optimum picture quality signal. A 300-ohm twin lead cable can be easily affected by radio noise and the like, resulting in signal deterioration. If you use a 300-ohm twin lead cable, keep it as far away from the TV as possible. Do not use an indoor antenna, which is especially susceptible to radio noise.

You can also connect a variety of optional equipment to your TV (see page 15). For multiple equipment connections, please refer to the separate Quick Setup Guide.

Cable System and VHF/UHF Antenna System

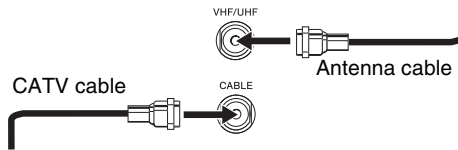

Press ANT to switch between VHF/UHF and cable.

Cable Box/Digital Cable Box and Antenna

To change channels using the cable box, set your TV to channel 3 or 4 depending on the cable box channel output.

Use this hookup if

- Your cable company scrambles some channels, such as premium channels. Viewing all channels requires a cable box.
- You do not intend to hook up any other audio or video equipment to your TV.

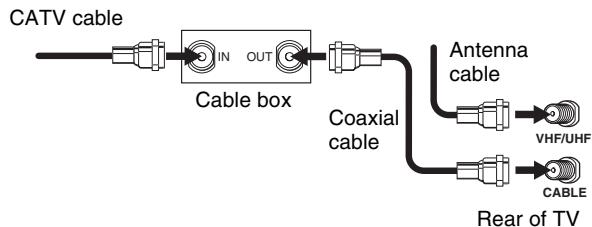

To set up the TV remote control, see “Programming the Remote Control” on page 26.

Press SAT/CABLE to begin operating the cable box with the remote control (see page 22). The indicator will light up.

Press ANT to switch between VHF/UHF and cable.

Cable Box/ Digital Cable Box

💡 To change channels using the cable box, set your TV to channel 3 or 4 depending on the cable box channel output.

Use this hookup if

- You subscribe to a cable TV system that uses scrambled or encoded signals requiring a cable box to view all channels, and
- You do not intend to hook up any other audio or video equipment to your TV.

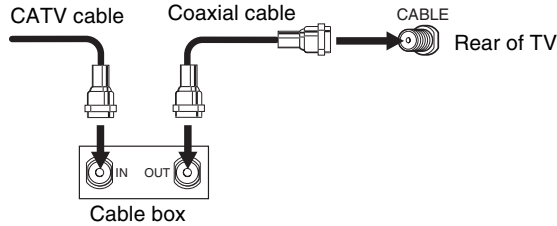

- 🔧 To set up the TV remote control, see “Programming the Remote Control” on page 26.
- 🔧 Press SAT/CABLE to begin operating the cable box with the remote control (see page 22). The indicator will light up.

Satellite Receiver and Cable/Antenna

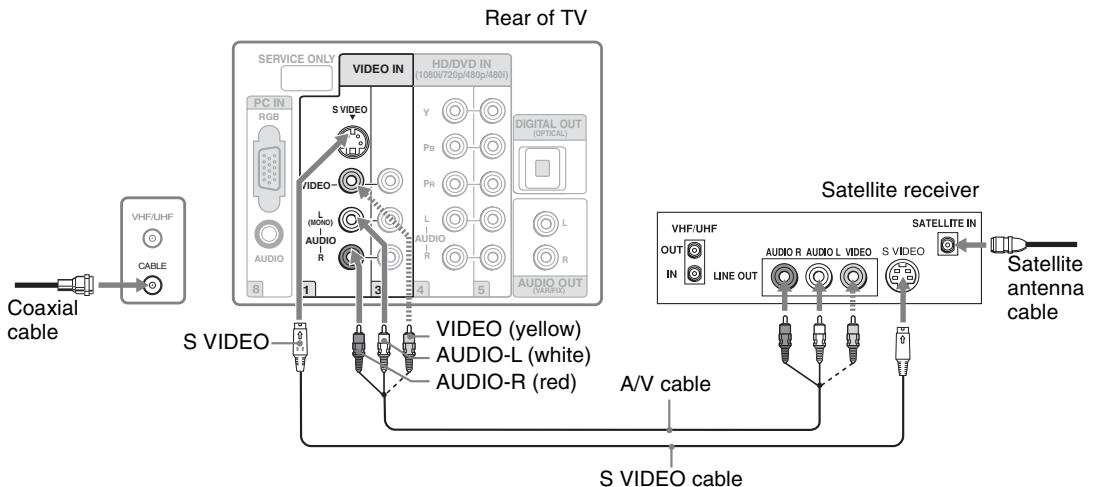

- 🔧 If your satellite receiver is not equipped with S VIDEO, use a VIDEO cable (yellow) instead of the S VIDEO cable.

VCR and Cable

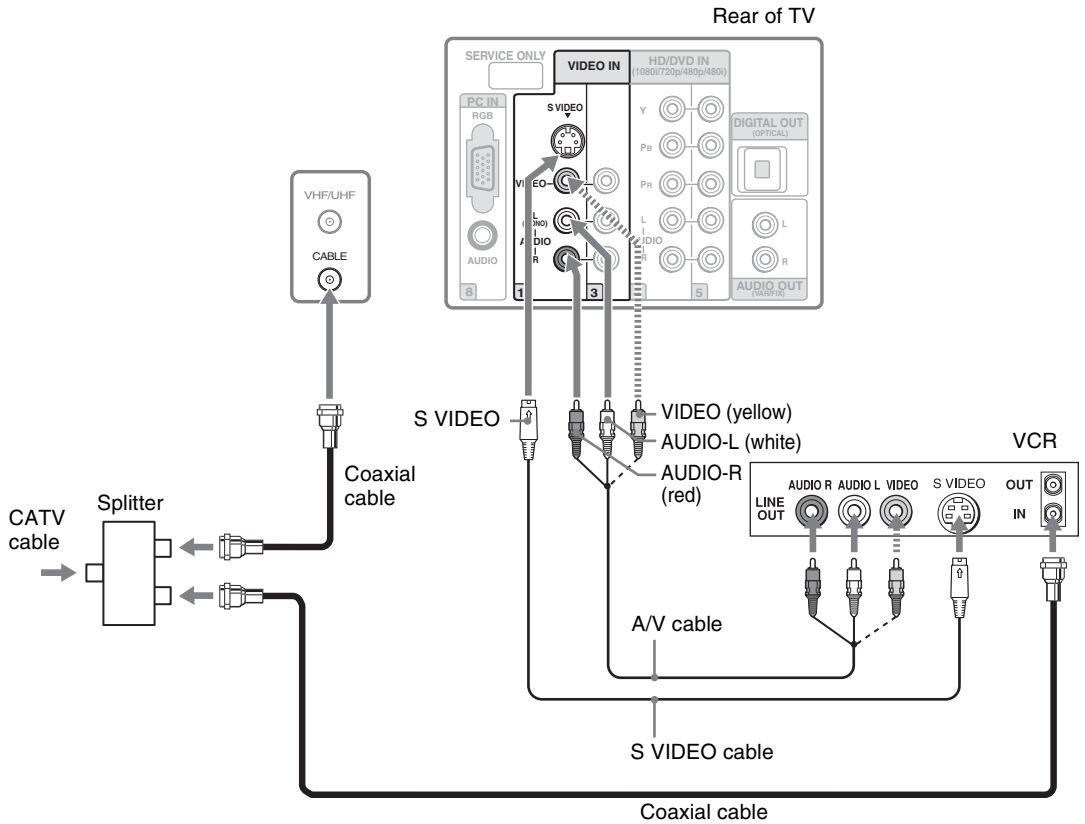

 If your VCR is not equipped with S VIDEO, use a VIDEO cable (yellow) instead of the S VIDEO cable.

VCR and Cable Box/ Digital Cable Box

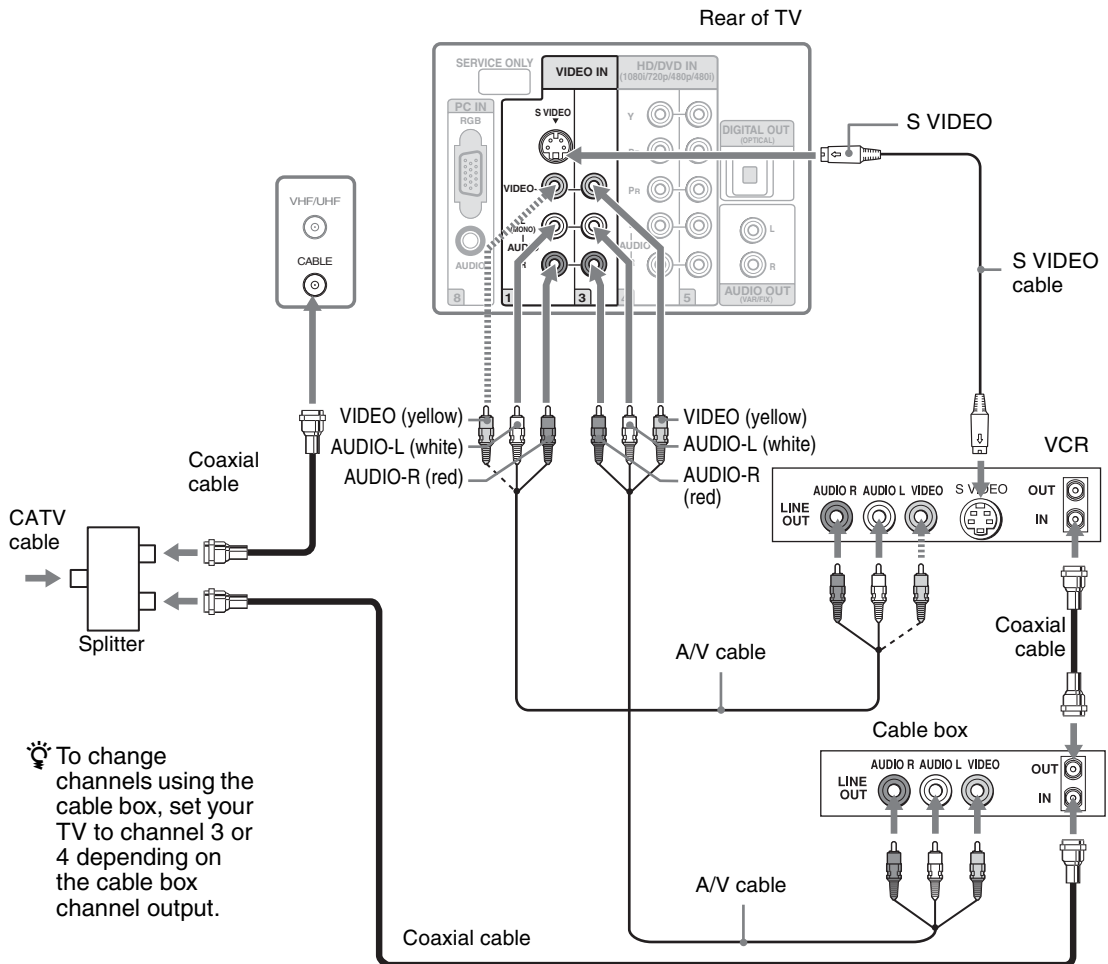

- ✎ If your VCR is not equipped with S VIDEO, use a VIDEO cable (yellow) instead of the S VIDEO cable.
- ✎ If you are connecting a digital cable box, you will need a special bidirectional splitter designed to work with your cable box.

When Connecting to Optional Equipment

Front Panel

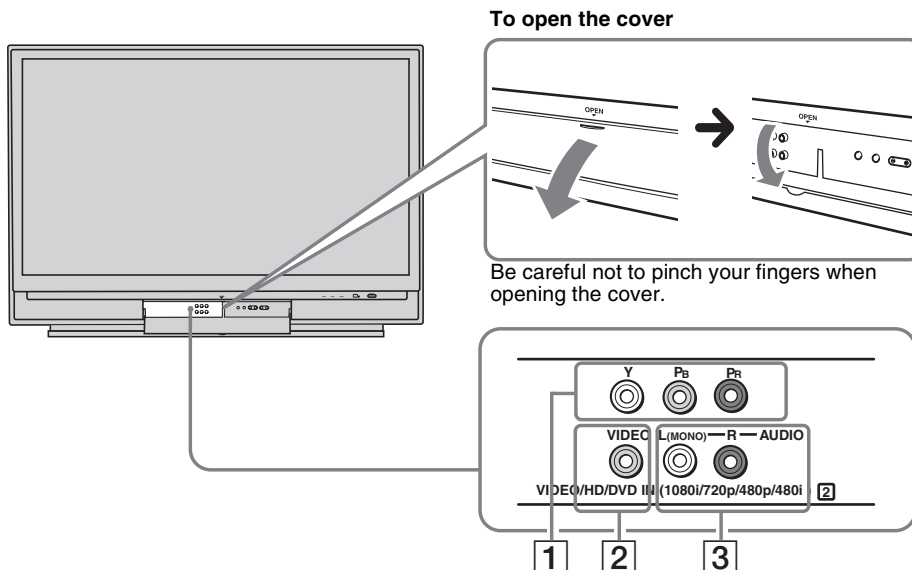

Jack	Description
1 HD/DVD IN 2 (1080i/720p/480p/480i)	Connects to your equipment's component video (Y P B P R) output jacks. Component video provides better picture quality than the S VIDEO (6) of rear panel) or the composite video (2) connection. When Auto is selected for the Video 2 (Component) option in the Setup settings, the component video function will be the default stream when present (see page 46). ⚠ Component video (Y P B P R) connection is necessary to view 480i, 480p, 720p, and 1080i formats. Note that this TV displays all format types of picture in a resolution of 1,920 dots × 1,080 lines.
2 VIDEO IN 2 VIDEO	Connect to the composite video output jacks on your camcorder or other video equipment such as video game equipment.
3 AUDIO IN 2 L (MONO)-R-AUDIO	Connects to the audio (L/R) output jacks of your equipment, including camcorders, video game equipment, to which you want easy access. ⚠ If you have mono equipment, connect its audio output jack to the TV's L (MONO) audio input jack.

⚠ When connecting composite video to VIDEO IN 2, be sure to select Video 2 (Component) to Off in the Setup settings to activate both audio and video function for composite connection (see page 46).

Rear Panel

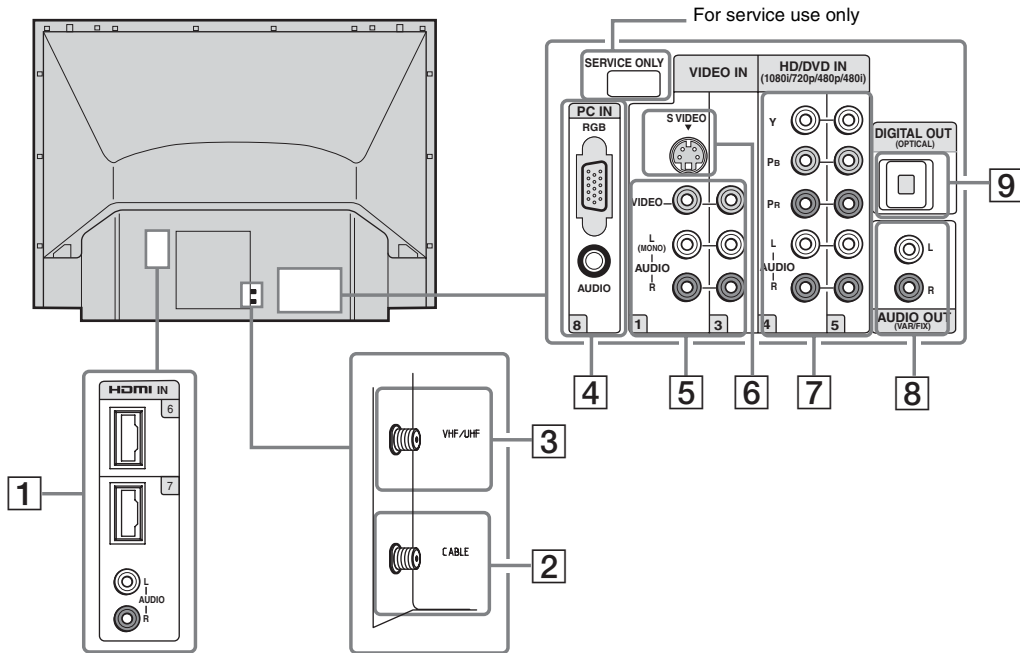

Jack	Description
1 HDMI IN 6/7 L-AUDIO-R	HDMI (High-Definition Multimedia Interface) provides an uncompressed, all-digital audio/video interface between this TV and any HDMI-equipped audio/video equipment, such as a set-top box, Blu-ray Disc Player, DVD player, and A/V receiver. HDMI supports enhanced, or high-definition video, plus two-channel digital audio. If the equipment has a DVI jack and not an HDMI jack, connect the DVI jack to the HDMI IN 7 (with HDMI-to-DVI cable and/or adapter) jack, and connect the audio jack to the AUDIO IN(L/R) jacks of HDMI IN 7. (DVI connector is for video signals only.)



HDMI-to-DVI cable



HDMI adapter







Audio cable

- Be sure to use only an HDMI cable that bears the HDMI logo.
- Do not connect a PC to the TV's HDMI input. Use the PC IN (RGB IN) input instead when connecting a PC.
- HDMI connection is necessary to view 480i, 480p, 720p, 1080i, and 1080p formats. Note that this TV displays all format types of picture in a resolution of 1,920 dots × 1,080 lines.

(Continued)





Getting Started

Jack	Description
2 CABLE	Connects to your cable signal. This CABLE input jack, in conjunction with the VHF/UHF input jack, lets you set up your TV to switch between scrambled channels (coming through a cable box) and unscrambled cable channels. For details, see page 14.  VHF/UHF input receives over-the-air broadcast signal frequencies and CABLE input receives CATV signal frequencies.
3 VHF/UHF	Connects to your VHF/UHF antenna.
4 PC IN 8 (RGB/AUDIO)	Connect to a personal computer's video output connector using HD15-HD15 cable (analog RGB, not supplied). Can also be connected to other analog RGB devices. See "PC Input Signal Reference Chart" on page 60 for the signals that can be displayed.  For some Apple Macintosh computers, it may be necessary to use an adapter (not supplied). If this is the case, connect the adapter to the computer before connecting the HD15-HD15 cable.  If the picture is noisy, flickering or not clear, adjust the Phase and Pitch of the PC settings as described on page 50.
5 VIDEO IN 1/3 VIDEO/L (MONO)-AUDIO-R	Connect to the composite video and audio output jacks on your A/V equipment such as a VCR or other video equipment. A third composite video and audio jack (VIDEO 2) is located on the front panel of the TV.
6 VIDEO IN 1 S VIDEO	Connects to the S VIDEO output jack of your VCR or other video equipment that has S VIDEO. S VIDEO provides better picture quality than the composite video (5).
7 HD/DVD IN 4/5 (1080i/720p/480p/480i)/L-AUDIO-R	Connect to your equipment's component video (YPbPr) and audio (L/R) jacks. Component video provides better picture quality than the S VIDEO (6) or the composite video (5) connections.  Component video (YPbPr) connection is necessary to view 480i, 480p, 720p, and 1080i formats. Note that this TV displays all format types of picture in a resolution of 1,920 dots x 1,080 lines.
8 AUDIO OUT (VAR/FIX)	Connect to the left and right audio input jacks of your audio or video equipment. You can use these outputs to listen to your TV's audio through your stereo system.
9 DIGITAL OUT (OPTICAL)	Connects to the optical audio input of digital audio equipment that is PCM/Dolby* digital compatible. (DIGITAL OUT (OPTICAL) is only available for digital channels.)

* Manufactured under license from Dolby Laboratories. "Dolby" and the double-D symbol are trademarks of Dolby Laboratories.

Setting Up the Channel List - Initial Setup

After you finish connecting the TV, you can run the **Initial Setup** to create a list of available analog and digital channels. The **Initial Setup** screen appears when you turn on the TV for the first time after hooking it up.

- 1 Press  to turn on the TV.
The **Initial Setup** screen appears.
- 2 Press  to highlight the on-screen display language. Then press . The message “Start auto program now?” appears.
- 3 Press  to highlight “Yes” then press .



Auto Program performed through **Initial Setup** will automatically create a list of receivable channels from both VHF/UHF antenna and cable TV channels if both sources are connected.

If you choose to set up the channels at a later time, select the Auto Program option in the **Channel** settings to scan available channels (see page 41).

 If you select "No" during Initial Setup, the Initial Setup screen will reappear each time you turn on the TV until you complete Auto Program.

Basic Operations

Using the Remote Control

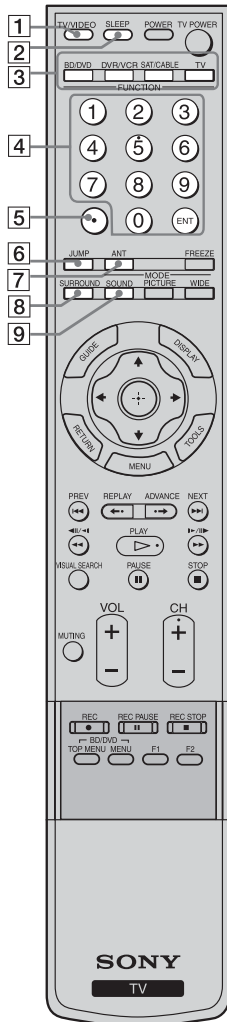

Button	Description
1 TV/VIDEO	Press repeatedly to cycle through the video inputs. See page 45 for information on setting up the video input labels, including the Skip function.
2 SLEEP	Press repeatedly until the TV displays the time in minutes (Off, 15, 30, 45, 60, 90 or 120) that you want the TV to remain on before shutting off. To cancel Sleep, press SLEEP repeatedly until Off appears.
3 FUNCTION Buttons	The FUNCTION button indicator lights up momentarily when pressed to show which external equipment the remote control is operating. When the remote control is set to operate the external equipment, these buttons will operate the equipment you choose. You must first press one of these FUNCTION buttons to operate the corresponding equipment. See page 26 for programming the remote control.
4 0 - 9, ENT	Press 0-9 to select a channel; the channel changes after two seconds. Press ENT to change channels immediately.
5	Use with the 0-9 and ENT buttons to select digital channels. For example, to enter 2.1, press 2 , . , 1 and ENT.
6 JUMP	Press to jump back and forth between two channels. The TV alternates between the current channel and the last channel that was selected.
7 ANT	Press to change between the VHF/UHF input and the CABLE input.
8 SURROUND	Press to select TruSurround XT audio effect or Off to turn this feature off.
9 SOUND	Press to cycle through different sound settings: Dynamic for enhanced treble and bass, Standard for spoken dialog and Custom for flat setting.

The 5 button, CH + button and PLAY button have a tactile dot. Use the tactile dot as a reference when operating the TV.

Insert two size AA (R6) batteries (supplied) by matching the **+** and **-** on the batteries to the diagram inside the remote control's battery compartment.

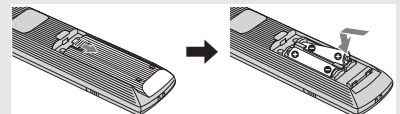

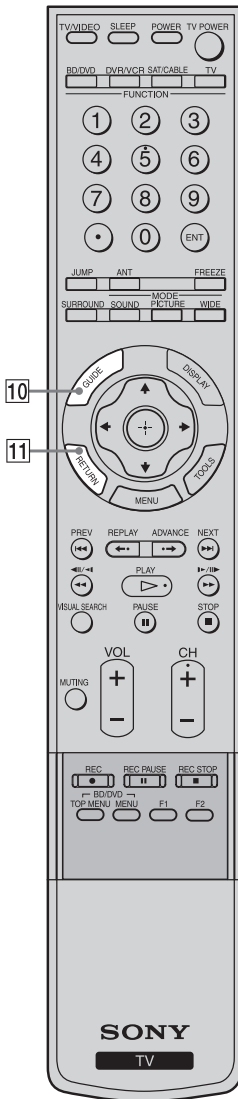

Button Description

10 GUIDE

Press to display the guide when you are watching analog or digital channels.

Using the Guide

The guide allows you to select the channels from a channel list. The guide also provides information about the current program being shown on each channel (if information is available from the station).

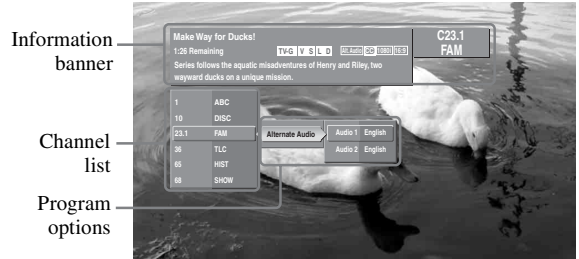

Program information in the guide is provided by the broadcasters. As a result, it may sometimes include only the channel number, without a program title or description.

Using the Program Options Setting

The program options setting allows you to customize the program settings on the currently tuned channel.

Alternate Audio Each program has a main audio stream (the (When available) audio you hear when the channel is first tuned), and may have alternate audio streams. This option allows you to switch among the alternate audio stream, when the broadcaster provides an alternate audio stream (for instance, the audio may contain a different language).

11 RETURN

Press to go back to the previous screen when displaying MENU items and settings.

(Continued)

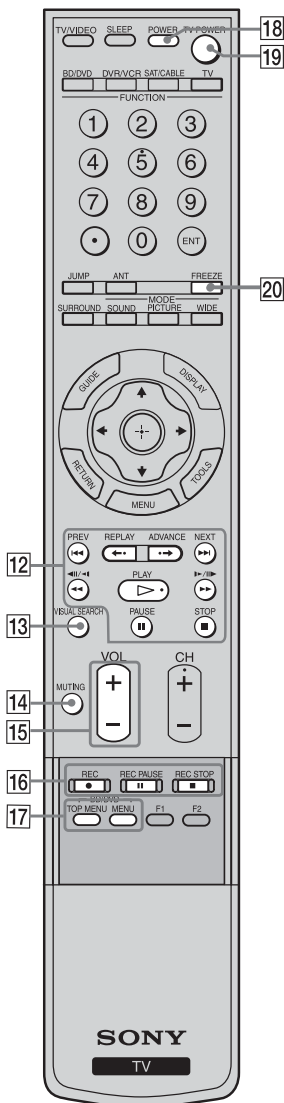





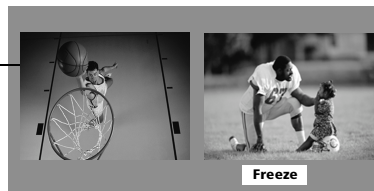



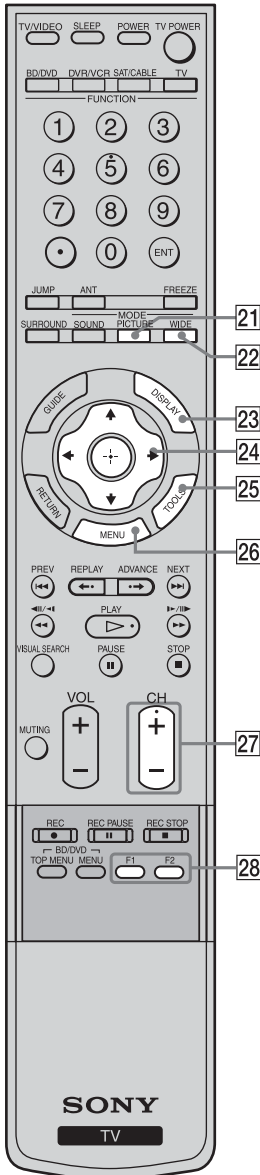

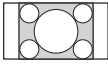

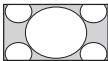





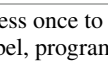
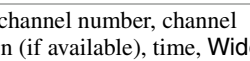
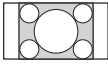

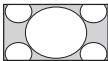





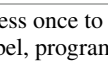
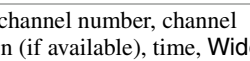
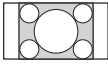

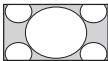
Button	Description
12	<p>BD/DVD, DVR/VCR Operating Buttons</p> <p>When FUNCTION is switched on BD (Blu-ray Disc)/DVD or DVR/VCR, these buttons operate the video equipment you have programmed into the remote control. For details, see “Using Other Equipment with Your Remote Control” on page 28.</p> <p>◀◀ PREV: Press to replay the current program from the previous chapter mark (if any) or from the beginning of the live TV cache.</p> <p>◀◀◀ REPLAY: Press to replay the current program for a set period of time.</p> <p>▶▶ ADVANCE: Press to advance forward a set period of time when playing back a recorded program.</p> <p>▶▶▶ NEXT: Press to advance forward to the next chapter mark (if any) or to live TV when playing back a recorded program.</p> <p>◀◀◀ (fast reverse): Press to play a program in fast rewind mode.</p> <p>▷ PLAY: Press to play a program at a normal speed.</p> <p>▶▶▶ (fast forward): Press to play a program in fast forward mode.</p> <p>⏸ PAUSE: Press to pause playback.</p> <p>■ STOP: Press to stop the playback of a recorded program.</p>
13	<p>VISUAL SEARCH</p> <p>Only for Sony DVD recorders with the visual search function. For details, see the operating instructions supplied with the DVD recorder.</p>
14	<p>MUTING</p> <p>Press to mute the sound. Press again or press VOL + to restore the sound.</p> <p> The MUTING function is not available when Speaker is set to Off and Audio Out is set to Fixed.</p>
15	<p>VOL +/-</p> <p>Press to adjust the volume.</p>
16	<p>DVR/VCR Record Buttons</p> <p>● REC: Press to record. Pressing this button alone starts the recording process.</p> <p>⏸ REC PAUSE: Press to pause the recording.</p> <p>■ REC STOP: Press to stop the recording.</p>
17	<p>BD/DVD TOP MENU/MENU</p> <p>Press to display the top menu or menu.</p> <p> For further information, refer to the operating manual of the connected equipment.</p>
18	<p>POWER</p> <p>Press to turn on and off the external equipment selected from the FUNCTION buttons [3].</p>
19	<p>TV POWER</p> <p>Press to turn on and off the TV.</p>
20	<p>FREEZE</p> <p>Press once to display a frozen image of the current program. Press again to return to the program.</p>

Current program in progress

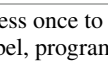
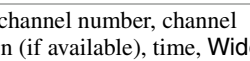
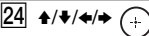

Frozen picture



Button	Description										
21 PICTURE	Press repeatedly to cycle through the available picture modes: Vivid, Standard, Custom. The picture modes can be also accessed in the Picture settings. For details, see “Picture Settings” on page 34.										
22 WIDE	Press repeatedly to step through the Wide Mode settings: Wide Zoom, Normal, Full, Zoom. The Wide Mode settings can be also accessed in the Screen settings. See page 39. Changing the Wide Screen Mode <table border="1" style="width: 100%; text-align: center;"> <tr> <td style="width: 50%; vertical-align: top;"> 4:3 Original source Standard definition source  </td> <td style="width: 50%; vertical-align: top;"> 16:9 Original source High definition source  </td> </tr> <tr> <td style="vertical-align: top;"> Wide Zoom  </td> <td style="vertical-align: top;"> Wide Zoom  </td> </tr> <tr> <td style="vertical-align: top;"> Normal  </td> <td style="vertical-align: top;"> Normal  </td> </tr> <tr> <td style="vertical-align: top;"> Full  </td> <td style="vertical-align: top;"> Full  </td> </tr> <tr> <td style="vertical-align: top;"> Zoom  </td> <td style="vertical-align: top;"> Zoom  </td> </tr> </table>	4:3 Original source Standard definition source 	16:9 Original source High definition source 	Wide Zoom 	Wide Zoom 	Normal 	Normal 	Full 	Full 	Zoom 	Zoom 
4:3 Original source Standard definition source 	16:9 Original source High definition source 										
Wide Zoom 	Wide Zoom 										
Normal 	Normal 										
Full 	Full 										
Zoom 	Zoom 										
23 DISPLAY	Press once to display the current channel number, channel label, program-related information (if available), time, Wide Mode settings and remaining sleep time (when Sleep is set, see page 46). The OSD (on screen display) will turn off automatically in a few seconds, or you can press DISPLAY again to turn it off immediately.										
24  	Press  to move the on-screen cursor. Press  to select/confirm an item.										
25 TOOLS	Press to access the Tools menu with commonly used options such as: Picture Mode, Sound Mode, Wide Mode, Add to Favorites, Caption Vision (CC) and Alternate Audio.  The menus you can select may vary depending on the input signal.										
26 MENU	Press to display the MENU with TV functions and settings. See “Overview of MENU” on page 32.										
27 CH +/-	Press to scan through channels. To scan quickly through channels, press and hold down either +/-.										
28 F1/F2	Press to select the function of connected components. For details, see “Using Other Equipment with Your Remote Control” on page 28.										

Programming the Remote Control

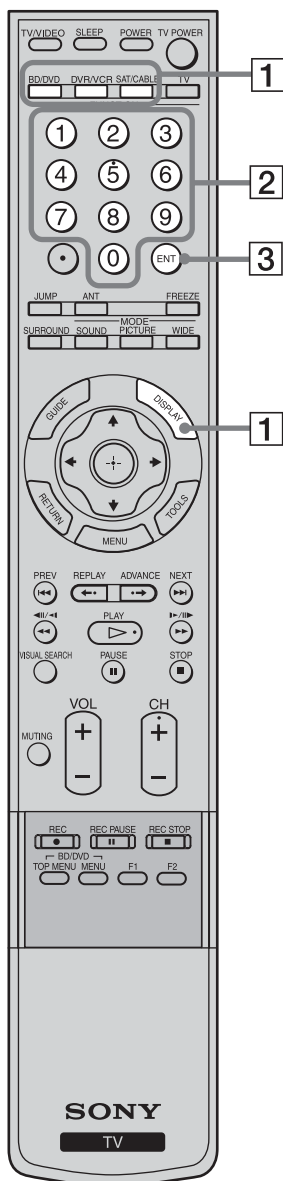

The remote control is preset to operate Sony brand video equipment.

Sony Equipment	Programmable Code Number
BD/DVD	101 (Sony Blu-ray Disc Player)
DVR/VCR	901 (Sony Dream System)
SAT/CABLE	801 (Sony Satellite Receiver)

Follow the steps below to program your TV's remote control to operate non-Sony video equipment.

Find the three-digit code for your equipment from the "Manufacturer's Codes" listed on page 27. If more than one code number is listed, try entering from the code listed first.

- 1 Press and hold the , or FUNCTION button you want to program on the remote control and press the button simultaneously. The selected FUNCTION button (BD/DVD, DVR/VCR or SAT/CABLE) will flash.
- 2 Enter the three-digit manufacturer's code number using the buttons while the FUNCTION button is lit. If the code is not entered within 10 seconds, you must start again from step 1.
- 3 Press the button while the FUNCTION button is lit. When the programming is correct, the selected FUNCTION button blinks twice, and when not, blinks five times.

While , and buttons are labeled as such, you can still program any of your connected equipment using any one of the buttons regardless of the label. For example, button can be programmed to operate your VCR. If you have a DVD/VCR combo that you want to operate with your TV remote control, you can program with the or or even the , but remember which button you have programmed for your particular use.

To check if the code works

Aim your TV's remote control at the equipment, and press the green button. If you can turn the equipment on and off by using the remote control, then the programming is complete. If not, try the next code listed.

If no code is input within the above specified time, or an invalid or incorrect code number is input, the remote control automatically goes back to the previous setting.

In some cases, you may not be able to program your remote control to operate other equipment. In such cases, use the equipment's own remote control.

Manufacturer's Codes

DVD Players

Manufacturer	Code
Sony	751, 763
General Electric/RCA	755
Hitachi	758
JVC	756
Magnavox	757
Mitsubishi	761
Oritron	759
Panasonic	753
Philips	757
Pioneer	752, 778
RCA/PROSCAN	755
Samsung	758
Toshiba	754
Zenith	760, 762

DVD/VCR Combo Units

Manufacturer	Code
Sony	767
Broksonic	776
JVC	775
Panasonic	777
Samsung	774
Toshiba	773
Zenith	768

HDD/DVD Combo Units

Manufacturer	Code
Sony	770, 771, 772

DVD Changers

Manufacturer	Code
Sony	765
Panasonic	766

DVR

Manufacturer	Code
Sony	901

Blu-ray Disc Player (BD)

Manufacturer	Code
Sony	101, 102, 103

5.1ch DVD AV System

Manufacturer	Code
Sony (DAV)	601, 602, 603, 604

AV Receivers

Manufacturer	Code
Sony	764

VCRs

Manufacturer	Code
Sony	301, 302, 303 (VHS, 8mm, Beta)

Manufacturer	Code
Sony DV	348
Admiral (M. Ward)	327
Aiwa*	338, 344
Audio Dynamic	314, 337
Broksonic	317, 319
Canon	308, 309
Citizen	332
Craig	302, 332
Curtis Mathes	304, 309, 338
Daewoo	309, 312, 341
DBX	314, 336, 337
Dimensia	304
Emerson	316, 317, 318, 319, 320, 341
Fisher	330, 335
Funai	338
General Electric	304, 309, 329
Go Video	322, 339, 340
Goldstar	332
Hitachi	304, 305, 306, 338
Instant Replay	308, 309
JC Penney	304, 305, 309, 314, 330, 336, 337
JVC	314, 336, 337, 345, 346, 347
Kenwood	314, 332, 336, 337
LG	332
LXI (SEARS)	305, 330, 332, 335, 338
Magnavox	308, 309, 310
Marantz	314, 336, 337
Marta	332
Memorex	309, 335
Minolta	304, 305
Mitsubishi/MGA	323, 324, 325, 326
Multitech	321, 325, 338
NEC	314, 336, 337
Olympic	308, 309
Optimus	327
Orion	317
Panasonic	306, 307, 308, 309
Pentax	304, 305
Philco	308, 309
Philips	308, 309, 310
Pioneer	308
Quasar	306, 308, 309
RCA/PROSCAN	304, 305, 308, 309, 310, 311, 312, 313, 329
Realistic	309, 324, 328, 330, 335, 338
Sansui	314

Manufacturer	Code
Samsung	313, 321, 322
Sanyo	330, 335
Scott	312, 313, 321, 323, 324, 325, 326, 335
Sharp	327, 328
Signature 2000 (M. Ward)	327, 338
SV2000	338
Sylvania	308, 309, 310, 338
Symphonic	338
Tashiro	332
Tatung	314, 336, 337
Teac	314, 336, 337, 338
Technics	308, 309
Toshiba	311, 312
Wards	327, 328, 331, 332, 335
Yamaha	314, 330, 336, 337
Zenith	331

Cable Boxes

Manufacturer	Code
Sony	230
Hamlin/Regal	222, 223, 224, 225, 226
Jerrold/General Inst./Motorola	201, 202, 203, 204, 205, 206, 207, 208, 218, 222
Oak	227, 228, 229
Panasonic	219, 220, 221
Pioneer	211, 214, 215
Scientific Atlanta	209, 210, 211
Tocom	216, 217
Zenith	212, 213

Satellite Receivers

Manufacturer	Code
Sony	801
Dish Network	810
Echostar	810
General Electric	802
Hitachi	805
Hughes	804
JVC	810
Mitsubishi	809
Panasonic	803
Philips	811
RCA/PROSCAN	802, 808
Toshiba	806, 807
Samsung	812

* If an Aiwa VCR does not work even though you enter the code for Aiwa, enter the code for Sony instead.

Using Other Equipment with Your Remote Control

To operate other equipment connected to your TV, first turn to page 27 and program the necessary code. For operating video equipment, press TV/VIDEO repeatedly until you see the video input on the screen for your connected equipment. Remote control tips are provided below.

 Some functions cannot be operated depending on the equipment. In that case, operate by the remote control supplied with the equipment.

Operating a Cable Box

To Do This ...	Press ...
Activate the remote control to operate the cable box	SAT/CABLE (FUNCTION)
Turn on/off	POWER

Operating a Satellite Receiver

To Do This ...	Press ...
Activate the remote control to operate the satellite receiver	SAT/CABLE (FUNCTION)
Turn on/off	POWER
Select a channel	0-9, ENT
Change channels	CH +/-
Back to previous channel	JUMP

Operating a VCR

To Do This ...	Press ...
Activate the remote control to operate the VCR	DVR/VCR (FUNCTION)
Turn on/off	POWER
Change channels	CH +/-
Record	●
Play	▷
Stop	■

Operating a DVD Player or DVD Changer

To Do This ...	Press ...
Activate the remote control to operate the DVD	DVD/VCR (FUNCTION)
Turn on/off	POWER
If you have a DVD changer, to skip disc	F1
Play	▷
Stop	■
Pause	(press again to resume normal playback)

To Do This ...	Press ...
Select a channel	0-9, ENT
Change channels	CH +/-
Back to previous channel	JUMP

To Do This ...	Press ...
Display channel number	DISPLAY
Display SAT Guide	GUIDE
Display SAT Menu	MENU
Move highlight (cursor)	↑ ↓ ← →
Select item	⊕

To Do This ...	Press ...
Fast forward	▶▶
Rewind the tape	◀◀
Pause	(press again to resume normal playback)
Select a channel	0-9, ENT
INPUT SELECT	TV/VIDEO

To Do This ...	Press ...
Step through different tracks of the disc	◀◀ to fast reverse or ▶▶ to fast forward the disc when pressed during playback
Step through different chapters of the disc	▶▶ to step forward or ◀◀ to step backward
Select a track directly	0-9, ENT
Display the disc menu or top menu	BD/DVD MENU or TOP MENU
Display the system MENU	MENU
Operate the DVD menu	↑ ↓ ← →, ⊕

Operating a Blu-ray Disc Player (BD)

To Do This ...	Press ...
Activate the remote control to operate the Blu-ray Disc Player	BD/DVD (FUNCTION)
Turn on/off	POWER
Play	▷
Stop	■
Pause	⏸ (press again to resume normal playback)

Operating a 5.1ch DVD AV System (Sony DAV)

To Do This ...	Press ...
Activate the remote control to operate the DVD	BD/DVD (FUNCTION)
Turn on/off	POWER
Select other equipment connected to the DAV	F1
Disk skip	F2
Display the disc menu or top menu	BD/DVD MENU or TOP MENU
Select a track directly	0-9, ENT

Operating a DVD/VCR Combo Unit

To Do This ...	Press ...
Activate the remote control to operate the DVD/VCR	DVR/VCR (FUNCTION)
Turn on/off	POWER
Select the DVD Select the VCR	F 1 F 2
Display the disc menu or top menu	BD/DVD MENU or TOP MENU
Play	▷
Stop	■
Pause	⏸

To Do This ...	Press ...
Step through different tracks of the disc	◀◀ to fast reverse or ▶▶ to fast forward the disc when pressed during playback
Display the POP UP menu (BD)	BD/DVD MENU
Display the disc menu (DVD)	BD/DVD MENU
Display the top menu (BD)	BD/DVD TOP MENU
Display the top menu (DVD)	BD/DVD TOP MENU
Operate the menu	⬆ ⬇ ⬇ ⬆, ⊕

To Do This ...	Press ...
Play	▷
Stop	■
Pause	⏸
Search the picture forward or backward	▶▶ or ◀◀ during playback
Specify the previous chapter/track Specify the next chapter/track	◀◀ ▶▶
Move highlight (cursor)	⬆ ⬇ ⬇ ⬆
Select item	⊕
Master volume	VOL +/-, MUTING

To Do This ...	Press ...
Search the picture forward or backward	▶▶ or ◀◀ during playback
Move highlight (cursor) and select (DVD)	⬆ ⬇ ⬇ ⬆ ⊕
Record (VCR)	●
Change channels (VCR)	CH +/- or 0-9, ENT (using tuner)
Adjust tracking (VCR)	CH +/- (during tape playback)
Index search	◀◀ ▶▶
INPUT SELECT	TV/VIDEO

(Continued)

Basic Operations

Operating a HDD/DVD Combo Unit

To Do This ...	Press ...
Activate the remote control to operate the DVD/HDD	DVR/VCR (FUNCTION)
Turn on/off	POWER
Select the HDD Select the DVD	F 1 F 2
Play	▷
Stop	■
Pause	⏸
Search the picture forward or backward	▶▶ or ◀◀ during playback
Move highlight (cursor) and select	⬆ ⬇ ⬇ ⬆ ⊕

Operating an AV Receiver

To Do This ...	Press ...
Activate the remote control to operate the AV Receiver	DVR (FUNCTION)
Turn on/off	POWER

Operating a DVR

To Do This ...	Press ...
Activate the remote control to operate the DVR	DVR/VCR (FUNCTION)
Turn on/off	POWER
Play	▷
Jump back while viewing live or record programs	REPLAY
Slow mode	◀◀/◀◀ (press lightly)
Jump forward while viewing recorded programs	•➡

To Do This ...	Press ...
Record	●
REC PAUSE	⏸
REC STOP	■
Specify the previous chapter/track Specify the next chapter/track	◀◀ ▶▶
Replay	◀•
Advance	•➡
Display the disc menu or top menu	BD/DVD MENU or TOP MENU
INPUT SELECT	TV/VIDEO

To Do This ...	Press ...
Master volume	VOL +/-, MUTING
Select other input connected to AV receiver	F1

To Do This ...	Press ...
Jump forward to the next available chapter	▶▶
Stop	■
Pause	⏸
Record	●
Record Stop	■
Record Pause	⏸

TV Controls

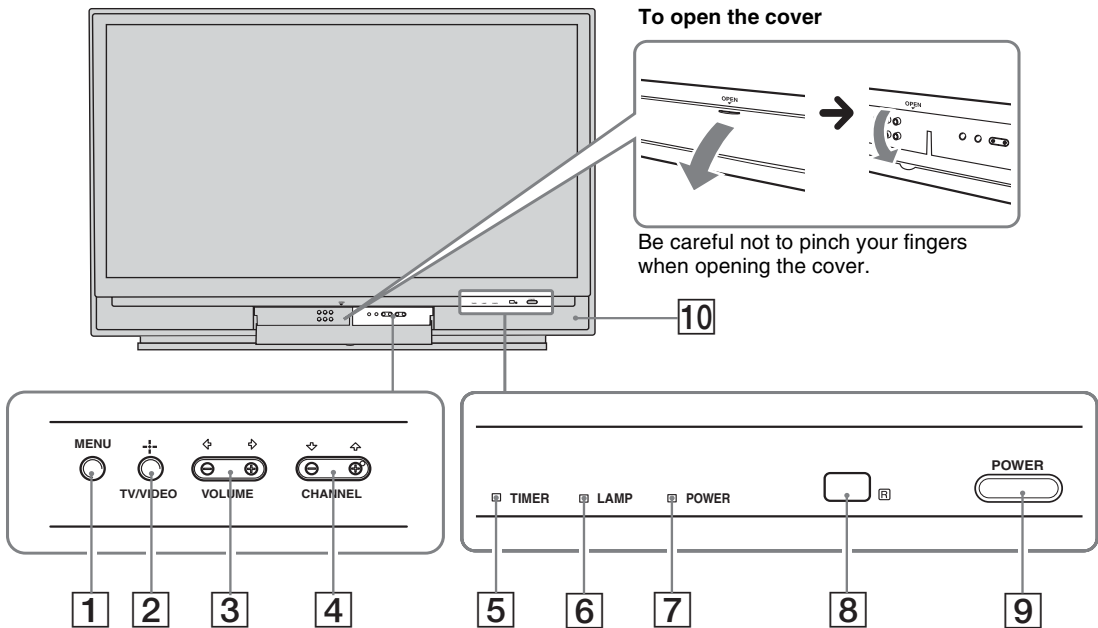

Item	Description
1	MENU Press to display MENU with TV functions and settings (see “Overview of MENU” on page 32).
2	+/- TV/VIDEO Press to cycle through the video inputs. If you set a certain input to Skip in Label Video Inputs, then the input will not appear. For details, see page 45. In the MENU screen, this button serves as confirming the selection or setting.
3	VOLUME +/- Press to adjust the volume. In the MENU screen, these buttons serve as left/right buttons.
4	CHANNEL +/- Press to scan through channels. To scan quickly through channels, press and hold down either -/+ . In the MENU screen, these buttons serve as up/down buttons.
5	TIMER LED When the timer is set, this LED will remain lit even if the TV is turned off. For details, see page 46.
6	LAMP LED Blinks in red when the lamp for the light source has burned out. For details, see “Replacing the Lamp” on page 51.
7	POWER LED Lights up in green when the TV is turned on. If the LED blinks in red continuously, this may indicate the display unit needs servicing (see the contacting Sony information on page 2). When the red LED blinks only three times, the lamp door of the lamp unit or the lamp itself is not securely attached (see page 53).
8	(IR) Infrared Receiver Receives IR signals from the remote control. Do not put anything near the sensor, as its function may be affected.
9	POWER Press to turn on and off the TV.
10	Speaker Outputs the audio signal.

The CHANNEL + button has a tactile dot. Use it as a reference when operating the TV.

Using the Menus

Overview of MENU

MENU provides one-button access for controlling your TV. It enables you to perform a variety of tasks intuitively with a control panel on the screen rather than a variety of remote control button presses. When you press the MENU button, you can select from basic TV functions: External Inputs, Favorites, Cable, Antenna or Settings.



- 1 Press MENU on the remote. The MENU control panel appears.
- 2 Press \uparrow/\downarrow to highlight the item.
- 3 Press \odot to select an option. Press MENU to exit.

 A dot appears next to the icon of the currently active input (External Inputs, Cable, and Antenna only).

 When the TV is displaying the input from a connected PC, the menu only shows PC settings. For more information about PC settings, see page 49.

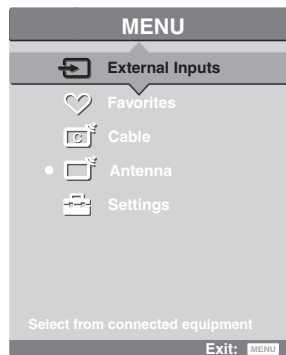

MENU

Description

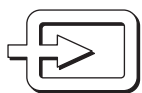

External Inputs

The External Inputs feature lets you select the external inputs connected to your TV. You can also assign a label using Label Video Inputs in the Setup settings (see page 45).

- 1 Highlight External Inputs on the MENU control panel and press \odot .
- 2 Press \uparrow/\downarrow to highlight the desired external input and press \odot .

 To display the PC settings, select Video 8 in External Inputs. For more information about PC settings, see page 49.

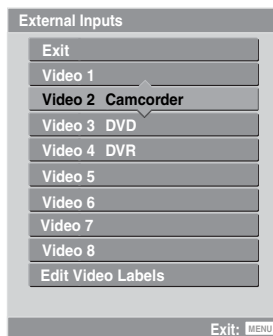

MENU**Description**

Favorites

The **Favorites** feature lets you select programs from a list of up to 16 favorite channels that you specify.

- 1 Highlight **Favorites** from the MENU control panel and press \odot . The **Favorite Channels** list appears.
- 2 Make your selection by pressing \uparrow/\downarrow to highlight the desired channel and then press \oplus . To add the current channel to the list of **Favorite Channels**, highlight **Add to Favorites** and press \oplus .

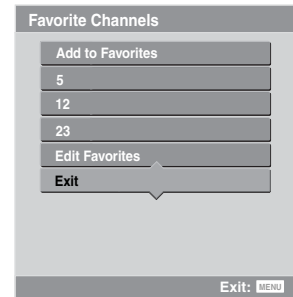

To manually edit your favorite channels, select **Edit Favorites**. For more information, see page 41.



Cable

The **Cable** feature displays the most recently viewed channel on the cable input. When tuned to the channel, the program banner and channel number will be displayed.

To turn on the program banner, select **Settings** and set the **Info Banner** option to **On** in the **Setup** settings (see page 45).

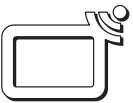

Antenna

The **Antenna** feature displays the most recently viewed channel on the antenna input. When tuned to the channel, the program banner and channel number will be displayed.

To turn on the program banner, select **Settings** and set the **Info Banner** option to **On** in the **Setup** settings (see page 45).



Settings

The **Settings** feature lets you enter the settings screen. Settings and adjustments can be performed from the **Settings** menu. The information on various settings starts from page 34.

Navigating Through Settings

- 1 Press **MENU**.
- 2 Select .
- 3 Highlight an item: **Picture**, **Sound**, **Screen**, **Channel**, **Parental Lock**, **Setup**.
- 4 Press \odot to select an option.

To exit the **Settings**, press **MENU**.



The options you can adjust vary depending on the situation. Unavailable options are grayed out or not displayed.



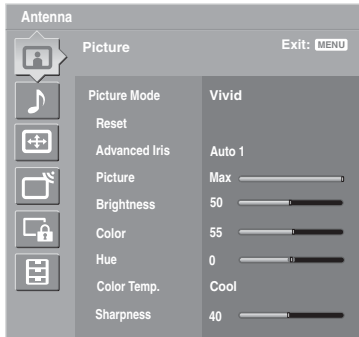



To display **PC** settings (page 49), select **Video 8** in **External Inputs** and switch to **PC** input. Pressing **MENU** shows **PC** settings when the TV is displaying the input from a connected **PC**.

Picture Settings



To display the Picture settings, see “Navigating Through Settings” (page 33).

Option	Description
Picture Mode	Vivid Select for enhanced picture contrast and sharpness.
	Standard Select for standard picture settings. Recommended for home entertainment.
	Custom Allows you to store your preferred settings.
	 You can set up a Picture Mode (Vivid, Standard, Custom) independently for the TV input and for each Video input (Video 1 to Video 7). Your Picture Mode settings are automatically saved upon selection.
Reset	Resets the current settings to default values (except for Advanced Settings).
Advanced Iris	By selecting the iris option, you can obtain the best brightness and contrast suited for your TV viewing.
	Auto 1/2 Automatically detects the brightness of the screen. This option is best suited for programs that often change between bright scenes and low light setting scenes.
	Auto 1: Recommended option for viewing programs that have larger variation in brightness from scene to scene.
	Auto 2: Recommended option for viewing programs that have less variation in brightness from scene to scene.
	Max With this option, the brightness is about the maximum level.
	High With this option, the screen is at a high level of brightness. It is suitable for TV viewing in a brightly lit room.
	Medium With this option, the brightness is about the standard level.
	Low With this option, the screen is dimmed but contrast is to the maximum. It is suitable for TV viewing in a room with low lighting.
Min With this option, the brightness is about the minimum level.	
 Advanced Iris is not available when you are using the Freeze feature.	
Picture	Adjust to increase or decrease picture contrast.
Brightness	Adjust to brighten or darken the picture.
Color	Adjust to increase or decrease color intensity.
Hue	Adjust to increase or decrease the green tones.

Option	Description
Color Temp. <i>White adjustment</i>	Cool Select to give the white colors a bluish tint.
	Neutral Select to give the white colors a neutral tint.
	Warm 1, 2 Select to give the white colors a reddish tint. Available only when Picture Mode is set to Custom.
Sharpness	Adjust to sharpen or soften the picture.
Noise Reduction	Select to reduce the noise level of connected equipment, and the VHF/UHF or cable inputs. Select from Auto, High, Medium, Low and Off.
	<p> Noise Reduction is not available when you are using the Freeze feature.</p> <p> Auto is not available when you are using either HDMI or component (except for Video 2) connections.</p>
DRC Mode	High Density Creates a high-resolution picture with 4 x density, for high-quality sources (i.e., Blu-ray Disc Player, DVD player, satellite receiver).
	Progressive Recommended for moving pictures.
	Off Select to turn off DRC Mode.
	 DRC Mode is available when you are watching 480i sources. It is not available when Game Mode is On or you are using the Freeze feature.
DRC Palette	Custom Allows you to customize the level of detail (Reality) and smoothness (Clarity) for input sources. For example, you can create a Custom setting for your cable input's picture, and create another for your DVD player's picture.
	<p>1 Press the arrow buttons to highlight Custom then press . The DRC palette appears.</p> <div data-bbox="610 904 854 1107" data-label="Image"> </div> <p>2 Press the arrow buttons to adjust the position of the marker (●). As you move the ● higher along the Reality axis, the picture becomes more detailed. As you move the ● to the right along the Clarity axis, the picture becomes smoother.</p> <p>3 To save the setting, press .</p> <p> DRC Palette is available when you are watching 480i sources. It is not available when Game Mode is On, DRC Mode is Off or you are using the Freeze feature.</p>

(Continued)



Using the Menus

Option	Description	
Advanced Settings <i>Available only when Picture Mode is set to Custom</i>	Reset	Resets all the Advanced Settings to default values (except for White Balance).
	Black Corrector	Enhances black areas of the picture for stronger contrast.
	Gamma	Adjusts the balance between the light and dark areas of the picture.
	Clear White	Emphasizes white and light colors.
	Live Color	Makes colors more vivid.
	White Balance	Adjusts the color temperature color by color.
	Detail Enhancer	Enhances the details of the picture.  Detail Enhancer is not available when you are using the Freeze feature.
	Edge Enhancer	Enhances the outline of the picture.

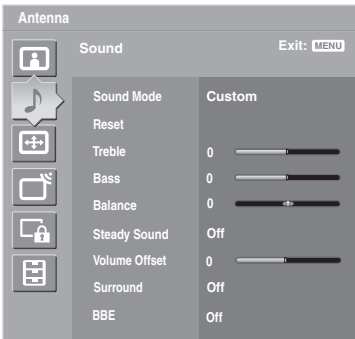
Sound Settings



To display the Sound settings, see “Navigating Through Settings” (page 33).

Option	Description
Sound Mode	Dynamic Select to enhance treble and bass.
	Standard Suitable for spoken dialog.
	Custom Flat setting. Allows you to store your preferred settings.
	 You can set up a Sound Mode (Dynamic, Standard, Custom) independently for the TV input and for each Video input (Video 1 to Video 7). Your Sound Mode settings are automatically saved upon selection.
Reset	Resets the following options to default values: Treble, Bass, Balance, Steady Sound, Volume Offset, Surround and BBE.
Treble	Adjust to increase or decrease higher-pitched sounds.
Bass	Adjust to increase or decrease lower-pitched sounds.
Balance	Adjust to emphasize left or right speaker balance.
Steady Sound	On Select to stabilize the volume across all programs and commercials.
	Off Select to turn off Steady Sound.
Volume Offset	Adjust the volume level of the current input (TV or video input) relative to other inputs.
Surround	TruSurround XT Select for surround sound (for stereo programs only).
	Off Select for normal stereo or mono reception.
BBE	Select to give sound more impact by compensating for phase effects in speakers. Select from High, Low and Off.
	 BBE is available only when Sound Mode is set to Custom.
MTS <i>Enjoy stereo, bilingual and mono programs</i>	Stereo Select for stereo reception when viewing a program broadcast in stereo.
	Auto SAP Select to automatically switch to second audio programs when a signal is received. If no SAP signal is present, the TV remains in Stereo mode.
	Mono Select for mono reception. Use to reduce noise during weak stereo broadcasts.
	 MTS is available only for analog programs.

(Continued)

Using the Menus

Option	Description	
Alternate Audio <i>Digital channels only</i>	Select among the available options to switch among the alternate audio streams. The program you are tuned to may be broadcast in a different language in the alternate audio streams.	
	 The Alternate Audio option is not available if the program is not broadcast with alternate audio streams.	
Speaker	On	Select to turn on the TV speakers.
	Off	Select to turn off the TV speakers and listen to the TV's sound only through your external audio receiver and speakers.
Audio Out <i>Easy control of volume adjustments</i>	Variable	The audio output from your audio system can be controlled by the TV's remote control.
	Fixed	The audio output of the TV is fixed. Use your audio receiver's remote control to adjust the volume (and other audio settings) through your audio system.
A/V Sync <i>Digital channel only</i>	Off/1/2/3	Use this option to make adjustments to audio and video synchronization when you have external equipment connected to DIGITAL OUT of the TV. Select Off (default value) to make no adjustments. Select 1 , 2 or 3 to synchronize the video and audio from your connected external equipment.

Screen Settings

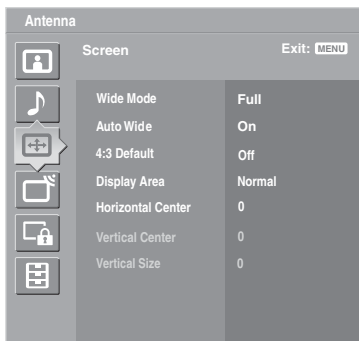













To display the Screen settings, see “Navigating Through Settings” (page 33).

Option	Description	
Wide Mode	Wide Zoom	Select to enlarge the 4:3 picture to fill the 16:9 screen, keeping the original image as much as possible.
	Normal	Select to display the 4:3 picture in its original size when the original source is 4:3. When the original source is 16:9, then the picture may be compressed horizontally.
	Full	Select to enlarge the picture horizontally to fill the screen when the original source is 4:3 (standard definition source). When the original source is 16:9 (high definition source), select this mode to display the 16:9 picture in its original size.
	Zoom	Select to enlarge the original picture without distorting the aspect ratio.
	 You can set up a Wide Mode (Wide Zoom, Normal, Full, Zoom) independently for the TV input and for each Video input (Video 1 to Video 7). Your Wide Mode settings are automatically saved upon selection. For examples of each mode, see page 25.	
Auto Wide	On	Select to automatically change to the screen mode that is best for the current program. If frequent screen changes are disturbing to you, select Off.
	Off	Select to turn off the Auto Wide option. Choose a screen mode from the Wide Mode option.

(Continued)



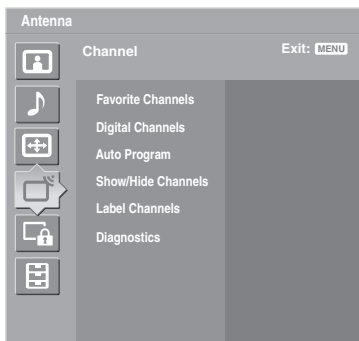

Using the Menus

Option	Description
4:3 Default <i>Select the default screen mode to use for 4:3 sources.</i>	Wide Zoom Select to enlarge the 4:3 picture, to fill the 16:9 screen, keeping the original image as much as possible.
	Normal Select to display the 4:3 picture in its original size.
	Full Select to enlarge the 4:3 picture horizontally only, to fill the display area.
	Zoom Select to enlarge the picture horizontally and vertically to an equal aspect ratio that fills the wide screen.
	Off Select to continue using the current Wide Mode setting when the channel or input is changed.
 4:3 Default is not available if Auto Wide is set to Off.	
 If 4:3 Default is set to anything but Off, the Wide Mode setting changes only for the current channel. When you change channels (or inputs), Wide Mode is automatically replaced with the 4:3 Default setting. To retain the current Wide Mode setting as channels and inputs are changed, set 4:3 Default to Off.	
Display Area	Allows you to adjust the screen area displaying the picture.
	Normal Select to display the picture in the original size.
	-1/-2 Select to enlarge the picture to hide the edge of the picture.
Horizontal Center	Allows you to move the position of the picture left and right. Press  /  and press  to adjust.
Vertical Center	Allows you to move the position of the picture up and down. (Available only in Zoom.) Press  /  and press  to adjust.
Vertical Size	Allows you to adjust the vertical size of the picture. (Available only in Wide Zoom and Zoom.) Press  /  and press  to adjust.
 Size adjustment is especially useful for Wide Zoom picture conditions such as when news ticker information appears at the bottom or top of the screen.	

Channel Settings



To display the Channel settings, see “Navigating Through Settings” (page 33).

Option	Description
Favorite Channels	<p>Lets you set up a list of up to 16 of your favorite channels.</p> <ol style="list-style-type: none"> 1 Press ▲/▼ to scroll to the slot you would like to edit. 2 Enter your favorite channel number and press ⊕ to apply and save. To select other favorite channel numbers, repeat steps 1-2. <p> To select favorite channel numbers that you specified, see page 33.</p>
Digital Channels	<p>Add Select to add digital channels.</p>
Auto Program	<p>Automatically sets up the channel list on the TV for all receivable channels for the current TV input (either Antenna or Cable).</p>
Show/Hide Channels	<p>Allows you to show or hide channels that appear in the program guide and when you use the CH+/- buttons to channel surf.</p> <ol style="list-style-type: none"> 1 Press ▲/▼ to highlight the channel that you want to show or hide. To move between the Major and Minor subchannel lists, press ◀/▶. 2 To change a channel's setting to Shown or Hidden, press ⊕. <p>To show or hide more channels, repeat steps 1 and 2.</p> <p> Channels that you set to be hidden can be accessed only with the 0-9 buttons.</p> <p> If you select to hide or show a major digital channel, all the subchannels are automatically hidden or shown. To show or hide an individual sub-channel within a digital channel, you must individually select that sub-channel to show or hide.</p> <p> If you hide all sub-channels of a major digital channel, that digital channel is automatically set to Hidden.</p>
Label Channels	<p>Allows you to assign labels (such as station call letters) to channel numbers.</p> <ol style="list-style-type: none"> 1 Press ▲/▼ to scroll through the channel numbers. Then press ⊕ to select the channel number that you want to assign a label. 2 Press ▲/▼ to scroll through the label characters (A-Z, 0-9, etc.). Press ⊕ to move to the next character. Repeat to add up to 7 characters to the label. To assign labels to more channels, repeat steps 1-2.
Diagnostics	<p>Display diagnostics information about the current channel and the TV. This can be useful in providing information to an authorized technician or repair person.</p>

Parental Lock Settings

To display the Parental Lock settings, see “Navigating Through Settings” (page 33).

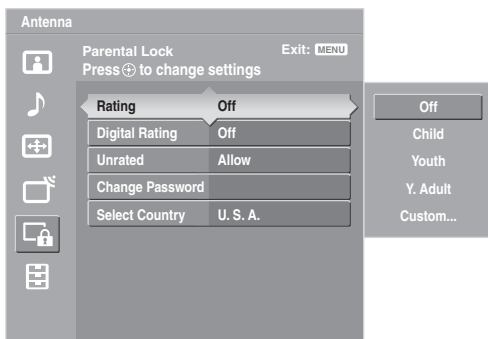







Option	Description
--------	-------------

The Parental Lock settings allows you to set up the TV to block programs according to their content and rating levels. Use 0-9 on the remote control to enter a four-digit password. The first time you create a password, confirm the password by entering it again.

Rating	Off	Turn Parental Lock off. No programs are blocked from viewing.
	Child	Maximum ratings permitted are: U.S.: TV-Y, TV-G, G Canada: C, G, TV-Y
	Youth	Maximum ratings permitted are: U.S.: TV-PG, PG Canada: C8+, PG, 8 ans+, TV-PG
	Y. Adult	Maximum ratings permitted are: U.S.: TV-14, PG-13 Canada: 14+, 13 ans+, TV-14
	Custom...	Select to set ratings manually. U.S.: See page 43 for details. Canada: See page 44 for details.

 If you are not familiar with the Parental Guideline rating system, you should select Child, Youth, or Y. Adult to help simplify the rating selection. To set more specific ratings, select Custom.

Option	Description	
Digital Rating <i>(Available only in U.S.A. where advanced ratings exist)</i>	Off	Turn Digital Rating off. No programs that contain downloadable ratings are blocked from viewing.
	Custom...	Select to block programs based on downloadable ratings.
	Clear All	Select to clear the entire downloadable rating system.
	 This action will delete the current Digital Rating menu and the menu will no longer be available until the TV is tuned to a channel that contains downloadable ratings.	
	 This icon  will appear on the information banner across the screen indicating the availability of the new downloadable rating information when the Digital Rating is set to the Custom option.	
	 This setting is only available if digital ratings have been downloaded by your TV and ratings have been set for U.S.A. in Select Country (see below).	
Unrated <i>(Available only in U.S.A.)</i>	Allow	Allows programs and movies that are broadcast without a rating.
	Block	Blocks all programs and movies that are broadcast without a rating.
	 If you block unrated TV programs, be aware that the following types of programs may be blocked: programs broadcast from another country, emergency broadcasts, political programs, sports, news, public service announcements, religious programs and weather.	
Change Password	Select to change your password.	
	 You need your password for any future access into the Parental Lock settings. If you lose your password, see "Lost password" on page 58.	
Select Country	U.S.A.	Select to use U.S.A. ratings (see below).
	Canada	Select to use Canadian ratings (see page 44).

US Models: Selecting Custom Parental Lock Rating Options

To select custom rating options for the U.S., select U.S.A. in the Select Country setting (see above).

Option	Description	
Movie Rating	G	All children and general audience.
	PG	Parental guidance suggested.
	PG-13	Parental guidance for children under 13.
	R	Restricted viewing, parental guidance is suggested for children under 17.
	NC-17 and X	No one 17 or under allowed.

(Continued)

Using the Menus

<i>Option</i>	<i>Description</i>	
TV Rating <i>Block programs by their rating, content or both</i>	Age-Based Ratings	
	TV-Y	All children.
	TV-Y7	Directed to children age 7 and older.
	TV-G	General audience.
	TV-PG	Parental guidance suggested.
	TV-14	Parents strongly cautioned.
	TV-MA	Mature audience only.
	Content-Based Ratings	
	FV	Fantasy violence.
	D	Suggestive dialogue.
	L	Strong language.
	S	Sexual situations.
	V	Violence.
	 To ensure maximum blocking capability, set the Age-Based Ratings.	

Canadian Models: Selecting Custom Parental Lock Rating Options

To select custom rating options for Canada, select **Canada** in the **Select Country** setting (see page 43).

<i>Option</i>	<i>Description</i>	
English Rating	C	All children.
	C8+	Children 8 years and older.
	G	General programming.
	PG	Parental guidance.
	14+	Viewers 14 and older.
	18+	Adult programming.
French Rating	G	General programming.
	8 ans+	Not recommended for young children.
	13 ans+	Not recommended for ages under 13.
	16 ans+	Not recommended for ages under 16.
18 ans+	Programming restricted to adults.	
U.S.A. Rating	See TV Rating for “US Models” above.	

Viewing Blocked Programs

You can view blocked programs by entering the password. Press **ENT** when tuned to a blocked program, then enter the password. This temporarily turns the parental control feature off. To reactivate the **Parental Lock** settings, turn off the TV. When the TV is turned on again, your **Parental Lock** settings are reactivated.



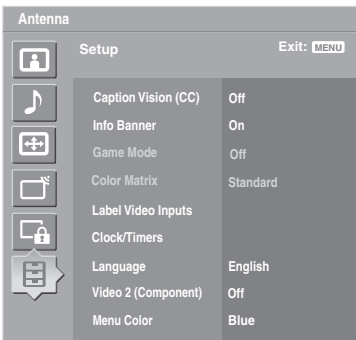

Setup Settings







To display the Setup settings, see “Navigating Through Settings” (page 33).

Option	Description
Caption Vision (CC)	Allows you to select from several closed-caption modes.
	On Caption Vision (CC) is turned on.
	Off Caption Vision (CC) is turned off.
	Program Allows you to set basic and advanced Caption Vision (CC) options. See “Programming Caption Vision (CC)” on page 48.
Info Banner	Set to On or Off. When On, displays the program name and the program information (if the broadcaster offers this service). Displays for few seconds when the channel is changed or the DISPLAY button is pressed.
Game Mode	On Select to optimize for playing games.
	Off Select to turn off the Game Mode.
	Game Mode is available when you are watching 480i or 1080i sources. It is not available when using the Freeze feature, or when receiving input from Cable or Antenna.
Color Matrix	Allows you to select the method for reproducing color-difference signals. It is recommended that you leave this at the factory default value.
	Standard Automatically optimizes based on signal.
	Custom... If the tone of the picture from the input source is unnatural, select either ITU601 or ITU709, which normalizes the tone.
Label Video Inputs	Allows you to identify A/V equipment you connected to the TV, such as a VCR, DVD, etc. For example, if you have a DVD player connected to the VIDEO 4 jack, you can select the label DVD for the Video 4 input. Then when you press TV/VIDEO to change inputs, the video label you assigned to that input appears on screen.
	1 Press to highlight the video input (Video 1-8) to which you want to assign a label. Then press to select the input.
	2 Press to highlight one of the displayed labels. Then press to select the label.
	You can select from the following labels for each input:
Video 1-7	—, DVD, Cable Box, Satellite, BD, VCR, Receiver, DVR, Game, Camcorder, Edit, Skip
Video 8	—, PC, Skip

(Continued)

Option	Description
	<p> Edit allows you to create a custom 10-character label. Steps to edit the labels are the same as Label Channels (see page 41).</p> <p> If you select Skip, your TV skips this input when you press the TV/VIDEO button.</p> <p> The Skip label is useful for inputs to which no equipment is connected.</p>
Clock/Timers	<p>Sleep Set the time in minutes (Off, 15 minutes, 30 minutes, 45 minutes, 60 minutes, 90 minutes or 120 minutes) that you want the TV to remain on before shutting off automatically.</p>
Timer 1 Timer 2	<p>You can use the timers to turn the TV on, set the duration time the TV will remain on, and tune to a specific channel at two scheduled times.</p> <p>Timer 1 and Timer 2 will not be available until you set the Current Time.</p> <p>1 Press ▲/▼ to highlight Timer 1 or Timer 2. To set the timer, press ▶.</p> <p> To go directly to programming Timer 1 or 2, press ⊕ instead of pressing ▶.</p> <p>2 Press ▲/▼ to highlight one of the following options, then press ⊕.</p> <p>Program: Select to set the timer by day, hour, minute, AM/PM, Duration, and Channel.</p> <p>Off: Select to turn off the timer. (Your previous settings are saved.)</p> <p>3 If you selected Program in step 2, press ▲ and ▼ to set the day(s), hour, minute, AM/PM, duration, and channel number. Press ⊕ or press ▶ to confirm each setting and move to the next setting. Press ◀ to go back to the previous setting.</p> <p>4 Press MENU to exit Settings.</p>
Current Time	<p>You can set the current time.</p> <p>1 Press ⊕ to select Current Time.</p> <p>2 Press ▲ and ▼ to set the current time (day, hour, minute, and AM/PM). Press ⊕ (or press ▶) to confirm each setting and move to the next setting. Press ◀ to go back the previous setting.</p> <p>3 Press MENU to exit Settings.</p>
Language	<p>Select to display all on-screen settings in your language of choice: English, Español, Français.</p>
Video 2 (Component)	<p>Auto Select to switch automatically between the component video jacks (YPbPr, AUDIO L (MONO)/AUDIO R) and the composite video jacks (VIDEO, AUDIO L (MONO)/AUDIO R) on the front of the TV (VIDEO/HD/DVD IN 2) depending on the cable connection.</p> <p>Off Select to activate the composite video jacks (VIDEO, AUDIO L(MONO)/AUDIO R) on the front of the TV.</p>
	<p> If you use the composite connection when Video 2 (Component) is set to Auto, do not connect the component cable at the same time. Otherwise select Off.</p>

<i>Option</i>	<i>Description</i>
Menu Color	Enables you to select a specific color for the on-screen settings.
Power Saving	Select to reduce the power consumption by adjusting the lamp brightness. This also enhances the black level. Select On or Off .
CineMotion	Select Auto to optimize the screen display automatically detecting film content and applying a reverse 3-2 pulldown process. Moving pictures will appear clearer and more natural looking. Select Off to disable the detection.  CineMotion is only available when you are watching 480i sources, except when the Freeze feature is in use.
Cooling Mode	Select High to use the TV at an altitude of 5,000 feet (1,500 m) or higher. Select Normal to use the TV at normal altitude.
Lamp Replacement	When the lamp nears the end of its life, a message appears every time you turn on the TV. After you replace the lamp, select this option and follow the on-screen procedure.  Select this option after you replace the lamp.  Depending on environmental conditions, such as frequency of use, some lamps may burn out before the lamp replacement message appears on the TV.  Until you set the Lamp Replacement option, a message announcing that the lamp is at the end of its life will appear every time you turn on the TV.
Product Information	Select to display the equipment information of your TV.

(Continued)

Programming Caption Vision (CC)

If you selected the Program option under Caption Vision (CC) (see page 45), you can change the following settings:

Option	Description	
Basic	Allows you to select basic analog (EIA-608) closed caption options.	
	CC1, CC2, CC3, CC4 Displays a printed version of the dialog or sound effects of a program. (Should be set to CC1 for most programs.)	
	Text1, Text2, Text3, Text4 Displays network/station information presented using either half or the whole screen (if available).	
Digital CC	Allows you to set digital closed captioning to Basic (digital EIA-608) or Advanced (digital EIA-708).	
Advanced	Allows you to select advanced digital (EIA-708) closed caption options. Select from the available options.	
Advanced Settings	Allows you to make additional settings for digital (EIA-708) closed caption options. Select from As Broadcast , Small Text , Large Text and Custom .	
	Custom...	Allows you to customize the following settings:
	Character Size	Small, Standard, Large
	Character Style	Style 1-7
	Character Color	Color 1-8
	Character Opacity	Solid, Translucent
	Edge Color	Color 1-8
	Edge Type	None, Raised, Depressed, Outline, Left Shadow, Right Shadow
	Background Color	None, Color 1-8
	Background Opacity	Solid, Translucent
	Window Color	None, Color 1-8
Window Opacity	Solid, Translucent	

PC Settings

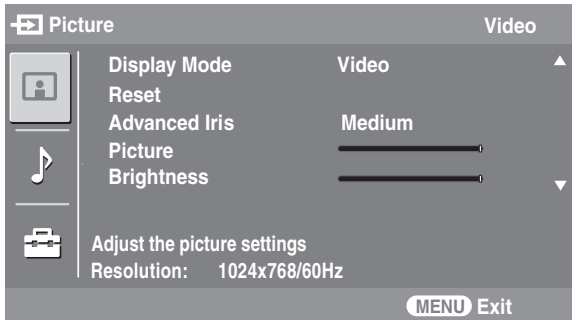

To display the PC settings, see “Navigating Through Settings” (page 33).

Press TV/VIDEO button to switch to another input.

Option	Description		
Picture	Display Mode	Video	Select to view video images.
		Text	Select to view text, charts or tables.
	Reset		Resets the current settings to default values.
Advanced Iris			By selecting the iris option, you can obtain the best brightness and contrast suited for your TV viewing.
		Auto 1/2	Automatically detects the brightness of the screen. This option is best suited for programs that often change between bright scenes and low light setting scenes.
			Auto 1: Recommended option for viewing programs that have larger variation in brightness from scene to scene.
			Auto 2: Recommended option for viewing programs that have less variation in brightness from scene to scene.
		Max	With this option, the brightness is about the maximum level.
		High	With this option, the screen is at a high level of brightness. It is suitable for TV viewing in a brightly lit room.
		Medium	With this option, the brightness is about the standard level.
	Low	With this option, the screen is dimmed but contrast is to the maximum. It is suitable for TV viewing in a room with low lighting.	
	Min	With this option, the brightness is about the minimum level.	
	Auto 1 and Auto 2 are not available when Display Mode is set to Text.		

(Continued)

Using the Menus

Option	Description
Picture	Adjust to increase or decrease picture contrast.
	Brightness Adjust to brighten or darken the picture.
	Color Temp. Cool Select to give the white colors a bluish tint.
White adjustment	Neutral Select to give the white colors a neutral tint.
	Warm 1,2 Select to give the white colors a reddish tint. Warm 2 gives a redder tint than Warm 1.
	Sound
Sound	Standard Provides standard sound. Recommended for home entertainment.
	Custom Provides a flat response.
	Others
Reset	Resets the current settings to default values.
Phase	Adjust after Pitch to fine tune overall sharpness.
Pitch	Adjust uneven sharpness on screen.
✎ For the PC Input Signal Reference Chart, see page 60.	
Horizontal Center	Allows you to move the position of the picture left and right. Press \leftarrow/\rightarrow and press $\odot+$ to adjust.
Vertical Center	Allows you to move the position of the picture up and down. Press \leftarrow/\rightarrow and press $\odot+$ to adjust.
Wide Mode	Normal Select to display in the original image size.
	Full 1 Select to enlarge the picture to fill the display area, keeping its original ratio.
	Full 2 Select to enlarge the picture to fill the display area.
✎ Wide Mode is available only for signals with a 60 Hz vertical frequency.	

Replacing the Lamp

The projection lamp, like all lamps, will eventually lose brightness and functionality, which affects the overall performance of your TV. How long the lamp maintains its brightness will vary depending upon your usage and environmental conditions. To maintain the quality of your viewing experience, Sony recommends that you replace the lamp (1) after approximately 8,000 hours of use; (2) when the screen becomes dark or the color looks unusual; (3) when the LAMP LED on the front of the TV blinks; or (4) when the lamp replacement message appears on the TV screen.



WARNING

Electric appliances can cause fire or high temperature, resulting in injury or death. Be sure to follow the instructions below.



- Use a Sony XL-5200 replacement lamp (not supplied) for replacement. Use of any other lamp may damage the TV.
- Do not remove the lamp for any purpose other than replacement. Doing so may cause injury or fire.
- Do not put flammable materials and metal objects inside the lamp receptacle of the TV after removing the lamp. Doing so may cause fire or electrical shock. Do not touch the lamp receptacle once the lamp has been removed.
- When the lamp eventually burns out, you may hear a noticeable pop sound. This is normal and it is inherent to this type of lamp.
- In rare instances, the bulb may pop inside the lamp unit, but the lamp unit is designed to contain all of the broken glass pieces inside the lamp unit.
- This TV's lamp contains mercury and should be disposed of properly. Consult your local authorities regarding safe disposal. The material contained in this lamp are similar to those of a fluorescent lamp, so you should dispose of it in the same way.

How to Replace the Lamp

- 1** Turn off the power on the main unit. Wait several minutes, then unplug the power cord.
(The cooling fan will continue to operate for about two minutes after turning the power off.)
- 2** Wait at least 30 minutes after unplugging the power cord to allow the lamp to cool down before replacing it. To avoid being burned, do not touch the lamp receptacle once the lamp has been removed.

(Continued)

- 3** Take the new lamp out of the box.
Do not touch the glass portion of the new lamp.

-  Do not shake the lamp. Vibration can damage the lamp or shorten its life.
-  Avoid touching the front glass of a new lamp or the glass of the lamp receptacle. This may reduce picture quality or lamp life.

- 4** Remove the outside lamp cover.
Release the two clamps as shown in the illustration below.

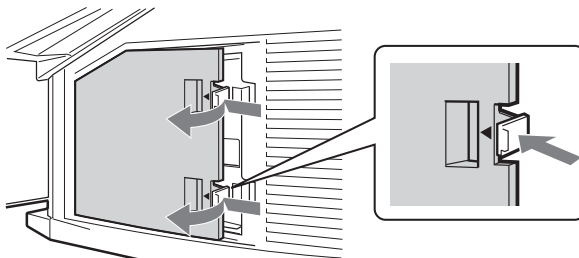

- 5** Remove the lamp door.
Turn the screw counterclockwise and slide the lever to the left. Remove the door.

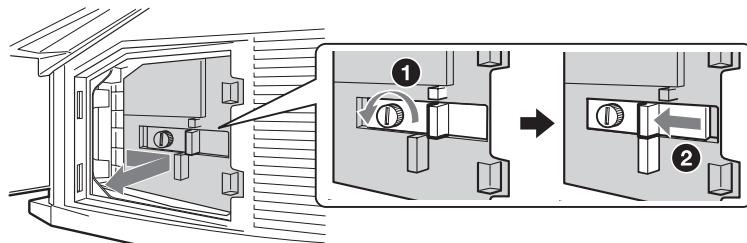

- 6** Pull out the lamp.
Hold the indented grooves on the top corners of the lamp, as shown in the illustration, and pull the lamp straight out. If the lamp is hard to remove, pull the right side of the lamp for additional traction.

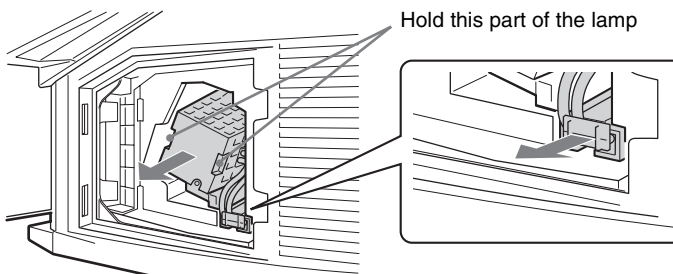

- ⚠ Do not touch the inside of the lamp compartment.
- ⚠ The lamp is very hot immediately after use. Never touch the glass portion of the lamp or the surrounding parts.
- ⚠ After the used lamp has cooled, place it into the empty box of the replacement lamp. Never put the used lamp into a plastic bag.

- 7** Put the new lamp into its place.
Insert the new lamp by pressing the two parts firmly into place as shown in the illustration. Make sure the lamp is securely mounted into the compartment. Failure to do so may cause a fire or the screen to go dark.

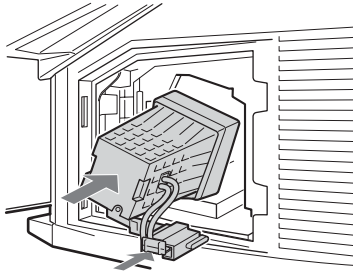

- ⚠ The lamp compartment is tilted, as shown in the following illustration.

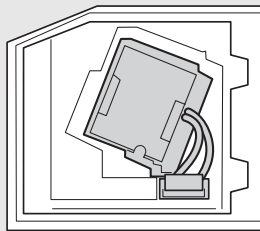

- ⚠ If the lamp is not securely reattached, the self-diagnostic function may be triggered and the POWER LED blinks three times (see page 31).

- 8** Reattach the lamp door.
Replace the door by inserting the two tabs in the slot from the left side. Slide the lever to the right and then turn the screw clockwise to secure the door.

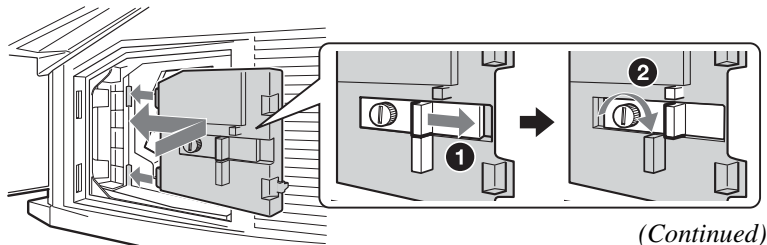

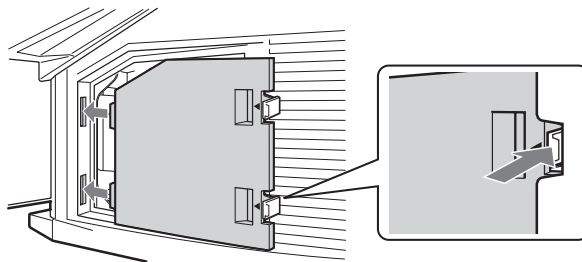

(Continued)

- 9** Put the outside lamp cover back in its place.
Replace the cover, inserting it from the left side. Press the two tabs on the right side to secure the cover.



- 10** Turn on the TV and set the Lamp Replacement option in the Setup settings (see page 47). This setting is necessary to inform you when the next lamp replacement is needed.

-  Until you set the Lamp Replacement option, a message announcing that the lamp is at the end of its life will appear every time you turn on the TV.
-  Consult your Sony dealer for a Sony XL-5200 replacement lamp.
-  Take great care when replacing the lamp or plugging in/unplugging the connecting cords. Rough handling may cause the TV to fall, damaging the TV, the TV stand and the floor.

The used lamp

For customers in the United States:

This product contains mercury. Disposal of this product may be regulated if sold in the United States. For disposal or recycling information, please contact your local authorities or the Electronics Industries Alliance (<http://www.eiae.org>).

- Do not leave the used lamp near flammable materials or within the reach of children.
- Do not pour water onto the used lamp or put any object inside the lamp. Doing so may cause the lamp to burst.

For replacement lamp information visit:

U. S. residents: <http://www.sonystyle.com/tv/>

Canadian residents: <http://www.sonystyle.ca/tv/>

Troubleshooting

If you have additional questions, service needs, or require technical assistance related to the use of your Sony TV, please visit our website or call one of the following numbers:

<http://www.sony.com/tvsupport>
 1-800-222-SONY(7669) for US
 1-877-899-SONY(7669) for Canada

Remote Control

Condition	Explanation/Resolution
Remote control does not operate	<ul style="list-style-type: none"> <input type="checkbox"/> The batteries could be weak. Replace the batteries. <input type="checkbox"/> Check the orientation of the batteries. <input type="checkbox"/> Press TV (FUNCTION) once, and the TV indicator lights up. You may have inadvertently pressed SAT/CABLE (FUNCTION), which changes the remote control to SAT or CABLE mode. <input type="checkbox"/> Make sure this unit's power cord is connected securely to the wall outlet. <input type="checkbox"/> Fluorescent lamps can interfere with remote control operation; try turning off the fluorescent lamps. <input type="checkbox"/> Keep the remote control sensor area clear from obstacles. <input type="checkbox"/> If the "WARNING: TV temperature is high." message appears, turn off the TV and wait until the TV's projection lamp cools down (approximately 5 minutes). If the remote control still does not work, make sure to dust the ventilation slots on the rear of the TV and the cooling fan to provide adequate ventilation around the TV.
Cannot change channels with the remote control	<ul style="list-style-type: none"> <input type="checkbox"/> If you are using the TV to change channels, first press TV (FUNCTION) once, and the TV indicator lights up. <input type="checkbox"/> If you are using another device to change channels, be sure you have not inadvertently switched your TV from the channel 3 or 4 setting. <input type="checkbox"/> If you are using another device to change channels, be sure to press FUNCTION for that device. For example, if you are using your cable box to change channels, be sure to press SAT/CABLE (FUNCTION) once, and the SAT/CABLE indicator lights up.
Remote control does not operate non-Sony video equipment	<ul style="list-style-type: none"> <input type="checkbox"/> If you replaced the batteries to the remote recently, the code numbers for the video equipment may need to be reset. <input type="checkbox"/> There may be more than one code for the equipment that you are attempting to operate. <input type="checkbox"/> There is a possibility that some non-Sony equipment cannot be operated by your Sony TV remote. You may need to use the equipment's original remote control.

Picture

Condition	Explanation/Resolution
No picture (screen not lit), no sound	<ul style="list-style-type: none"><input type="checkbox"/> If your TV does not turn on and the POWER LED keeps blinking in red, your TV may need service. Call your local Sony Service Center.<input type="checkbox"/> Make sure the power cord is plugged in.<input type="checkbox"/> Press POWER on the front of the TV.<input type="checkbox"/> Press TV/VIDEO to cycle through the connected video sources.<input type="checkbox"/> Try another channel; it could be station trouble.
Dark, poor or no picture (screen lit), good sound	<ul style="list-style-type: none"><input type="checkbox"/> Adjust the Picture Mode option in the Picture setting (see page 34).<input type="checkbox"/> Adjust the Brightness option in the Picture setting (see page 34).<input type="checkbox"/> Check the antenna/cable connections.
No color/dark picture/color is not correct	<ul style="list-style-type: none"><input type="checkbox"/> Adjust the Color option in the Picture setting (see page 34).<input type="checkbox"/> If you set the Power Saving option to On, it will enhance the black level.
Green tint or uneven color uniformity appears on the screen when the TV is powered on	<ul style="list-style-type: none"><input type="checkbox"/> After turning on the TV, you may notice a green tint or slight variation in color and brightness in certain areas of the picture. This will last only a few minutes (possibly longer, in cooler rooms or conditions) while circuits within the TV continually fine tune the color during the warm-up period. This is a normal temperature characteristic of the components and not a malfunction.
The TV turns off automatically	<ul style="list-style-type: none"><input type="checkbox"/> Check if the Sleep option is activated, or confirm the Duration setting of Timer (page 46).<input type="checkbox"/> If the temperature is too high, the TV may also turn off after a warning message is displayed.
Only snow and noise appear on the screen	<ul style="list-style-type: none"><input type="checkbox"/> Check the antenna/cable connections.<input type="checkbox"/> Try another channel; it could be station trouble.<input type="checkbox"/> Press ANT to change the input mode (see page 22).
Dotted lines or stripes	<ul style="list-style-type: none"><input type="checkbox"/> Move the TV away from noise sources such as cars, neon signs, or hair dryers.<input type="checkbox"/> If using 300 ohm twin lead, move the excess lead away from the TV or try using 75 ohm coaxial cable instead.
Double images	<ul style="list-style-type: none"><input type="checkbox"/> Using a highly directional outdoor antenna or a cable may solve the problem.
“Black box” on screen	<ul style="list-style-type: none"><input type="checkbox"/> You have selected a text option in the Caption Vision (CC) feature in the Setup setting and no text is available (see pages 45 and 48). To turn off this feature, set the Caption Vision (CC) option to Off. If you were trying to select closed captioning, select CC1 instead of Text 1-4.
Wide Mode changes automatically	<ul style="list-style-type: none"><input type="checkbox"/> The current Wide Mode setting is automatically replaced with the 4:3 Default setting when you change the channel or video input, if 4:3 Default in the Screen settings is set to other than Off. If you want to lock in the Wide Mode selected with the WIDE button, set 4:3 Default to Off in the Screen settings (see page 40).<input type="checkbox"/> Check the Auto Wide option in the Screen settings (see page 39).
Black bands appear at the top and bottom of the screen	<ul style="list-style-type: none"><input type="checkbox"/> Some wide-screen programs are filmed in aspect ratios that are greater than 16:9 (this is especially common with theatrical releases). Your TV will show these programs with black bands at the top and bottom of the screen. For more details, check the documentation that came with your DVD (or contact your program provider).

Condition	Explanation/Resolution
Certain programs on DVD or other digital sources display a loss of detail, especially during fast-motion or dark scenes	<ul style="list-style-type: none"> <input type="checkbox"/> The compression used by certain digital broadcasts and DVDs may cause your TV's screen to display less detail than usual, or cause artifacts (small blocks or dots, pixelations) to appear on your screen. This is due to your TV's large screen and ability to show very fine detail, and is normal for certain digitally recorded programs. Adjust the Reality/Clarity in the DRC Palette setting (see page 35) to optimize the picture while viewing these sources.

Sound

Condition	Explanation/Resolution
Good picture, no sound	<ul style="list-style-type: none"> <input type="checkbox"/> Press MUTING so that Muting disappears from the screen (see page 24). <input type="checkbox"/> Make sure the Speaker option is set to On in the Sound setting (see page 38). <input type="checkbox"/> Make sure the MTS option is set to Stereo or Mono (see page 37). <input type="checkbox"/> When the HDMI IN input is in use, surround sound, such as AC-3 and DTS, cannot be input. Change the sound setting for the external input device to Linear PCM.
Audio noise	<ul style="list-style-type: none"> <input type="checkbox"/> Make sure that the antenna is connected using the 75-ohm coaxial cable. <input type="checkbox"/> Keep the antenna cable away from other connecting cords. <input type="checkbox"/> To avoid TV interference, make sure to use an undamaged antenna cable.
Cannot gain enough volume when using a cable box	<ul style="list-style-type: none"> <input type="checkbox"/> Increase the volume of the cable box using the cable box's remote control. Then press TV (FUNCTION) once (the TV indicator lights up) and adjust the TV's volume.
Sound seems weak or insufficient	<ul style="list-style-type: none"> <input type="checkbox"/> The TV's audio might be set to Auto SAP or Mono, when it might be better set to Stereo. In the Sound setting (see page 37), set the MTS setting to Stereo. If already set to Stereo, switch to Mono (which may reduce background noise during weak stereo broadcasts).
Cannot raise the volume on external speakers	<ul style="list-style-type: none"> <input type="checkbox"/> If the Speaker option is set to Off and the Audio Out option is set to Fixed (in order to output the sound to your audio system), use your audio receiver to adjust the sound (see page 38). Or, to use the TV remote control, set the Audio Out option to Variable. <input type="checkbox"/> To turn on the TV speakers, set the Speaker option to On (see page 38).
No audio for HDMI	<ul style="list-style-type: none"> <input type="checkbox"/> Confirm DVD player, set-top-box audio settings. Select 2 channel LPCM audio.

Channels

Condition	Explanation/Resolution
Cannot receive upper channels (UHF) when using an antenna	<ul style="list-style-type: none"> <input type="checkbox"/> Press ANT to select the VHF/UHF input (see page 22). <input type="checkbox"/> Use Auto Program in the Channel setting to add receivable channels that are not presently in the TV's memory (see page 41).
Cannot receive any channels when using cable TV	<ul style="list-style-type: none"> <input type="checkbox"/> Use Auto Program in the Channel setting to add receivable channels that are not presently in the TV's memory (see page 41). <input type="checkbox"/> Press ANT to select the CABLE input (see page 22).
Cannot receive or select channels	<ul style="list-style-type: none"> <input type="checkbox"/> Use Auto Program in the Channel setting to add receivable channels that are not presently in TV memory (see page 41).

Other Information

Condition	Explanation/Resolution
Some digital cable channels are not being displayed	<ul style="list-style-type: none">❑ Certain cable companies have limitations on the broadcast of digital cable channels. Check with your cable company for more information.❑ The digital cable channel may be set to Hidden in the Channel setting (see page 41).

General

Condition	Explanation/Resolution
How to reset the TV to factory settings	<ul style="list-style-type: none">❑ Turn on the TV. While holding down the ▲ button on the remote control, press the POWER button on the TV. Release the POWER button then release the ▲ button. The TV will turn itself off, then back on again with Initial Setup. WARNING: This operation will clear all of your customized settings including Parental Lock setting.
How to restore Picture settings to factory settings	<ul style="list-style-type: none">❑ Select Reset setting option while in the Picture setting (see page 34).
How to restore Sound settings to factory settings	<ul style="list-style-type: none">❑ Select Reset setting option while in the Sound setting (see page 37).
Cannot cycle through the other video equipment connected to the TV	<ul style="list-style-type: none">❑ Be sure the Label Video Inputs option is not set to Skip (see page 45).
Cannot operate the setting	<ul style="list-style-type: none">❑ If a setting option appears in gray, this indicates that the setting option is not available.
Lost password	<ul style="list-style-type: none">❑ On the password screen, enter the following master password: 4357. The master password clears your previous password; it cannot be used to temporarily unblock channels.
TIMER LED on front panel is lit	<ul style="list-style-type: none">❑ When lit, indicates that the timer is set (see page 46). When the timer is set, this LED will remain lit even when the TV is turned off.
POWER LED blinks in red	<ul style="list-style-type: none">❑ If the LED blinks three times, the lamp door or the lamp might not be securely attached (see page 51). The LED blinks two times if there is an abnormal rise in temperature inside the TV when any ventilation openings are blocked.
LAMP LED blinks in red	<ul style="list-style-type: none">❑ Replace the lamp (see page 51).
The replacement lamp does not light up	<ul style="list-style-type: none">❑ The lamp door or the lamp might not be securely attached. Repeat the steps on page 51 to ensure that they are both installed securely.
Digital cable box does not work	<ul style="list-style-type: none">❑ If you are connecting a VCR and digital cable box using a splitter, as described on page 17, you must use a special bi-directional splitter that is designed to work with your digital cable box. Contact your cable provider for details.
TV cabinet creaks	<ul style="list-style-type: none">❑ When the TV is in use, there is a natural rise in temperature, causing the cabinet to expand or contract and may be accompanied by a slight creaking noise. This is not a malfunction.
A slight creaking noise occurs from the bottom part of the TV	<ul style="list-style-type: none">❑ Advanced Iris applies a mechanical iris system. When Advanced Iris is set, a natural creaking noise occurs due to the basic structure of the optical unit. The creaking sound is an inherent nature of this system and is not a defect.
The cooling fan is loud	<ul style="list-style-type: none">❑ If the TV is used at high altitudes and Cooling Mode is set to High, the cooling fan runs faster and its sound becomes louder. If the TV is not used at high altitudes, set Cooling Mode to Normal (see page 47).

Condition	Explanation/Resolution
“High Temperature Warning” message appears	<input type="checkbox"/> Make sure to remove dust from the ventilation slots on the rear and both sides of the TV. In addition, make sure that there are no obstacles in front of the ventilation slots. If the message still appears after the dust or obstacles are removed, the TV may need servicing. Call your local Sony Service Center.
The TV does not turn on	<input type="checkbox"/> The TV cools down its projection lamp when the power is turned off. It takes up to two minutes for the picture to come back after the TV is turned on again. Wait for a while until the picture comes back.
Small bright or black dot in picture	<input type="checkbox"/> It may be possible to see one or two pixels, which appear dark or bright when viewing up close to the screen caused during the manufacturing of the display device. This is not a defect with your TV and will not affect the overall picture performance or reliability of your set. Please view the screen at the recommended viewing distances.
Image left on the screen (image retention)	<input type="checkbox"/> Turn off the TV for a while or let the TV run on another channel. Unlike plasma TV and CRT TV, image retention on this TV <u>is not permanent</u> . It is only a temporary condition; see page 10.
White spot on the screen when powered off	<input type="checkbox"/> If screen is exposed to direct sunlight or strong ambient light, part of the screen may appear white even when TV is power off. This is due to the strong light reflecting off the TV screen and reflections coming behind the screen. This is a structural property of the projection TV and is not a defect. Position your TV away from such light sources.
“Projection lamp is nearing end of life. Please replace the lamp.” message appears	<input type="checkbox"/> It is time for you to replace the projection lamp used in your TV. <ul style="list-style-type: none"> • Turn to page 51 on “How to Replace the Lamp” and follow the directions for replacing the lamp. • Use only the lamp designated for your TV model. • Set the Lamp Replacement option in the Setup settings (see page 47).

PC Input Signal Reference Chart

Resolution				Horizontal frequency (kHz)	Vertical frequency (Hz)	Standard
Signals	Horizontal (Pixel)	×	Vertical (Line)			
VGA	640	×	480	31.5	60	VGA
	640	×	480	37.5	75	VESA
	720	×	400	31.5	70	VGA-T
SVGA	800	×	600	37.9	60	VESA Guidelines
	800	×	600	46.9	75	VESA
XGA	1024	×	768	48.4	60	VESA Guidelines
	1024	×	768	56.5	70	VESA
	1024	×	768	60.0	75	VESA
WXGA	1280	×	768	47.4	60	VESA
	1280	×	768	47.8	60	VESA
	1360	×	768	47.7	60	VESA

- 🔍 This TV's PC input does not support Sync on Green or Composite Sync.
- 🔍 The PC input signal displays on-screen in a smaller size than the actual TV screen size and does not support interlaced signals.
- 🔍 For the best picture quality, it is recommended to use the signals (boldfaced) in the above chart with a 60 Hz vertical frequency from a personal computer. In plug and play, signals with a 60 Hz vertical frequency will be selected automatically.

Specifications

Television system:

NTSC	American TV Standard
ATSC (8VSB terrestrial)	ATSC compliant 8VSB
QAM on cable	ANSI/SCTE 07 2000 (Does not include CableCARD functionality)

Channel coverage:

Terrestrial (analog)	2-69
Cable TV (analog)	1-125
Terrestrial (digital)	2-69
Cable TV (digital)	1-135

Antenna:

75-ohm external terminal for VHF/UHF

Screen size (measured diagonally):

KDS-50A2000:	50 inches
KDS-55A2000:	55 inches
KDS-60A2000:	60 inches

Projection system

3 SXRD panel, 1 lens projection system

SXRD panel

0.61 inch SXRD panel 6,220,800 pixels (2,073,600 × 3)

Projection lens

High performance, large diameter hybrid lens F2.5

Lamp

Ultra High Pressure Lamp, 120W, XL-5200

VIDEO IN 1/2/3:

YPbPr (Component Video) (VIDEO 2 only):

Y:	1.0 Vp-p, 75 ohms unbalanced, sync negative
PB:	0.7 Vp-p, 75 ohms
PR:	0.7 Vp-p, 75 ohms
Signal format:	480i, 480p, 720p, 1080i

S VIDEO (4-pin mini DIN) (VIDEO 1 only):

Y:	1.0 Vp-p, 75 ohms unbalanced, sync negative
C:	0.286 Vp-p (Burst signal), 75 ohms

VIDEO: 1 Vp-p, 75 ohms unbalanced, sync negative

AUDIO: 500 mVrms (100% modulation)

Impedance: 47 kilohms

HD/DVD IN 4/5:

YPbPr (Component Video):

Y:	1.0 Vp-p, 75 ohms unbalanced, sync negative
PB:	0.7 Vp-p, 75 ohms
PR:	0.7 Vp-p, 75 ohms
Signal format:	480i, 480p, 720p, 1080i

AUDIO: 500 mVrms (100% modulation)

Impedance: 47 kilohms

HDMI IN 6/7:

HDMI: Video: 480i, 480p, 720p, 1080i, 1080p
Audio: Two channel linear PCM 32, 44.1 and 48 kHz, 16, 20 and 24 bits

AUDIO (for HDMI IN 7):

500 mVrms (100% modulation)
Impedance: 47 kilohms

AUDIO OUT:

500 mVrms (100% modulation)

More than 1 Vrms at the maximum volume setting (Variable)

500 mVrms (Fixed)

DIGITAL OUT (OPTICAL):

Optical Digital Audio Output (PCM/Dolby digital)

PC IN 8:

D-sub 15-pin, analog RGB, 0.7 Vp-p, 75 ohms, positive

See the PC Input Signal Reference Chart on page 60

PC AUDIO INPUT:

Stereo mini jack, 0.5 Vrms, 47 kilohms

Speaker:

Full range: 70 × 130 mm (2⁷/₈ × 5¹/₈ inches) (2)

Speaker output:

12 W + 12 W

Power requirement:

120 V AC, 60 Hz

Power consumption:

In use: 210 W

In standby: Less than 0.5 W

Dimensions (W/H/D):

KDS-50A2000: 1180 × 839 × 447 mm
(46¹/₂ × 33¹/₈ × 17⁵/₈ inches)

KDS-55A2000: 1292 × 913 × 480 mm
(50⁷/₈ × 36 × 19 inches)

KDS-60A2000: 1413 × 988 × 514 mm
(55³/₄ × 39 × 20¹/₄ inches)

Mass:

KDS-50A2000: 34 kg (75 lb.)

KDS-55A2000: 38 kg (83 lb. 13 oz.)

KDS-60A2000: 43 kg (94 lb. 13 oz.)

Supplied accessories:

Remote control RM-YD010 (1)

Size AA batteries (2)

Operating Instructions (1)

Quick Setup Guide (1)

Warranty Card (1)

Product Registration Card (1)

Optional accessories:

TV Stand: SU-RS11M(KDS-50A2000)

SU-RS11X(KDS-55A2000/KDS-60A2000)

Lamp: XL-5200

 The availability of optional accessories depends on its stock.

Design and specifications are subject to change without notice.

- 0-9 buttons 22
- 4:3 Default 40
- 5.1 Channel DVD using with remote control 29

A

- A/V Sync 38
- Advanced Iris 34, 49
- Advanced Settings 36
- Alternate Audio 23, 38
- ANT button 22
- AUDIO IN jack, described 18
- Audio Out 38
- AUDIO OUT jack, described 20
- Auto Adjustment 50
- Auto Program 41
- Auto Wide 39

B

- Balance 37
- Bass 37
- BBE 37
- BD/DVD MENU button 24
- BD/DVD TOP MENU button 24
- BD/DVD, DVR/VCR Operating buttons 24
- Black Corrector 36
- Blu-ray Disc Player
 - using with remote control 29
- Brightness 34, 50

C

- Cable, CABLE
 - connecting with VCR 16
 - jack, described 20
 - using with remote control 28
- Caption Vision (CC)
 - described 45
 - programming 48
- CH +/- button 25
- Change Password 43
- CHANNEL +/- button 31
- Channels
 - creating labels 41

- CineMotion 8, 47
- Clear White 36
- Clock/Timers 46
- Color 34
- Color Matrix 45
- Color Temp. 35, 50
- Connecting
 - Satellite receiver 15
 - VCR 16
- Cooling Mode 47

D

- Detail Enhancer 36
- Diagnostics 41
- Digital Channels 41
- DIGITAL OUT (OPTICAL) 20
- Digital Rating 43
- Display Area 40
- DISPLAY button 25
- Display Mode 49
- DRC Mode 35
- DRC Palette 35
- DVD player
 - using with remote control 28
- DVR/VCR Record buttons 24

E

- Edge Enhancer 36
- English Rating 44
- ENT button 22

F

- F1 button 25
- F2 button 25
- Favorite Channels 41
- FREEZE button 24
- French Rating 44
- FUNCTION buttons 22

G

- Game Mode 45
- Gamma 36
- Guide 23

- GUIDE button 23

H

- HD/DVD IN jack (1080i/720p/480p/480i), described 18, 20
- HDMI IN jack, described 19
- High-Definition Multimedia Interface (HDMI) 9
- Horizontal Center 40, 50
- Hue 34

I

- Info Banner 45
- Infrared Receiver (IR) 31

J

- JUMP button 22

L

- Label Channels 41
- Label Video Inputs 45
- LAMP LED 31
- Lamp Replacement 47
- Lamp, replacing 51–54
- Language 46
- Live Color 36

M

- MENU
 - Antenna 33
 - Cable 33
 - External Inputs 32
 - Favorites 33
 - Settings 33
- MENU button 25, 31
- Menu Color 47
- Movie Rating 43
- MTS 37
- MUTING button 24

N

- Noise Reduction 35

O

Off, turning off the TV 24, 31
On, turning on the TV 24, 31

P

Parental Control 8
Password, changing 43
PC IN jack 20
Phase 50
Picture 34, 50
PICTURE button 25
Picture Mode 34
Pitch 50
POWER button 24, 31
POWER LED 31
Power Saving 47
Problems, Troubleshooting 55–59
Product Information 47
Program options setting 23

R

Rating 42
Remote control
 inserting batteries 22
 programming 26, 27
Reset 34, 36, 37, 49, 50
RETURN button 23

S

S VIDEO jack, described 20
Satellite receiver
 connecting 15
 using with remote control 28
Select Country 43
Settings
 Channel 41
 Parental Lock 42
 PC 49
 Picture 34
 Screen 39
 Setup 45
 Sound 37
Sharpness 35
Show/Hide Channels 41
SLEEP button 22
SOUND button 22
Sound Mode 37, 50

Speaker 31, 38
Steady Sound 9, 37
Support Belt 11
Surround 37
SURROUND button 22

T

Timer
 set current time 46
TIMER LED 31
TOOLS button 25
Treble 37
Troubleshooting 55–59
Turning on/off the TV 24, 31
TV POWER button 24
TV Rating 44
TV/VIDEO button 22, 31

U

U.S.A. Rating 44
Unrated 43

V

VCR
 using with remote control 28
 with cable, connecting 16
Vertical Center 40, 50
Vertical Size 40
VHF/UHF jack, described 20
Video 1-7 45
Video 2 (Component) 46
Video 8 45
VIDEO IN jack, described 18, 20
VIDEO/AUDIO (L/R) jacks,
 described 20
Viewing Blocked Programs 44
VISUAL SEARCH button 24
VOL +/- button 24
VOLUME +/- button 31
Volume Offset 37

W

WEGA Engine 8
White Balance 36
WIDE button 25
Wide Mode 39, 50
Wide Screen Mode 8

